



MODEL:  
**DRPC-130-AL**

**Fanless Embedded System with Intel® Atom™ x5-E3930 CPU,  
Dual GbE, Digital IO, Serial Ports, Isolated CAN Bus,  
USB 3.2 Gen 1, Dual HDMI, 12V~24V DC Power Input,  
DIN Rail Mounting Support, RoHS Compliant**

# User Manual

# Revision

---

<b>Date</b>	<b>Version</b>	<b>Changes</b>
December 17, 2019	1.12	Modified Section 3.7: CAN Bus Connection
November 5, 2019	1.11	Added Section 3.5.1: mSATA/PCIe Mode Selection
August 22, 2018	1.10	Updated for R11 version – changing mounting method
June 5, 2018	1.00	Initial release

# Copyright

---

## **COPYRIGHT NOTICE**

The information in this document is subject to change without prior notice in order to improve reliability, design and function and does not represent a commitment on the part of the manufacturer.

In no event will the manufacturer be liable for direct, indirect, special, incidental, or consequential damages arising out of the use or inability to use the product or documentation, even if advised of the possibility of such damages.

This document contains proprietary information protected by copyright. All rights are reserved. No part of this manual may be reproduced by any mechanical, electronic, or other means in any form without prior written permission of the manufacturer.

## **TRADEMARKS**

All registered trademarks and product names mentioned herein are used for identification purposes only and may be trademarks and/or registered trademarks of their respective owners.

# Manual Conventions

---

**WARNING**

Warnings appear where overlooked details may cause damage to the equipment or result in personal injury. Warnings should be taken seriously.

**CAUTION**

Cautionary messages should be heeded to help reduce the chance of losing data or damaging the product.

**NOTE**

These messages inform the reader of essential but non-critical information. These messages should be read carefully as any directions or instructions contained therein can help avoid making mistakes.

**HOT SURFACE**

This symbol indicates a hot surface that should not be touched without taking care.

**PROTECTIVE EARTH GROUND**

Indicates protective earth ground

**IEC 60417-5009: STAND-BY**

# Table of Contents

<b>1 INTRODUCTION.....</b>	<b>1</b>
1.1 OVERVIEW.....	2
1.2 MODEL VARIATIONS.....	3
1.3 FEATURES.....	3
1.4 FRONT PANEL.....	4
1.5 TOP PANEL.....	5
1.6 TECHNICAL SPECIFICATIONS.....	6
1.7 DIMENSIONS.....	8
<b>2 UNPACKING.....</b>	<b>9</b>
2.1 ANTI-STATIC PRECAUTIONS.....	10
2.2 UNPACKING PRECAUTIONS.....	10
2.3 PACKING LIST.....	11
2.4 OPTIONAL ITEMS.....	12
<b>3 INSTALLATION.....</b>	<b>13</b>
3.1 INSTALLATION PRECAUTIONS.....	14
3.1.1 <i>High Surface Temperature</i> .....	14
3.2 INTERNAL ACCESS PANEL REMOVAL.....	15
3.3 SO-DIMM INSTALLATION (OPTIONAL).....	16
3.4 HDD INSTALLATION.....	17
3.5 PCIe MINI CARD INSTALLATION (MSATA OR WWAN).....	18
3.5.1 <i>mSATA/PCIe Mode Selection</i> .....	19
3.5.2 <i>Full-size PCIe Mini Card Installation</i> .....	21
3.5.3 <i>Half-size PCIe Mini Card Installation</i> .....	23
3.5.4 <i>PCIe Mini Card Slot Pinouts – Full/Half Size (MPCIE1)</i> .....	25
3.6 WIRELESS LAN MODULE INSTALLATION (OPTIONAL).....	26
3.6.1 <i>PCIe Mini Card Slot Pinouts – Half Size (MPCIE2)</i> .....	29
3.7 CAN BUS CONNECTION.....	30
3.8 DIGITAL I/O CONNECTION.....	30
3.9 RS-232/422/485 SERIAL PORT CONNECTION.....	30



3.10 LAN CONNECTION.....	31
3.11 AT/ATX MODE SELECTION.....	32
3.12 DIN RAIL MOUNTING.....	33
3.13 POWER-ON PROCEDURE.....	35
3.13.1 Installation Checklist.....	35
3.13.2 Terminal Block Pinouts.....	35
3.13.3 Power-on Procedure.....	36
3.13.4 PS-ON, 2-pin Terminal Block.....	37
3.14 AVAILABLE DRIVERS.....	37
3.14.1 Driver Download.....	38
<b>4 TROUBLESHOOTING AND MAINTENANCE.....</b>	<b>40</b>
4.1 SYSTEM MAINTENANCE OVERVIEW.....	41
4.2 SYSTEM TROUBLESHOOTING.....	41
4.2.1 The System Doesn't Turn On.....	41
4.2.2 The System Doesn't Boot Up.....	42
4.2.3 More Troubleshooting.....	42
4.3 MAINTENANCE.....	42
4.3.1 Clear CMOS.....	43
4.3.2 TXE Override Jumper.....	44
<b>5 BIOS.....</b>	<b>45</b>
5.1 INTRODUCTION.....	46
5.1.1 Starting Setup.....	46
5.1.2 Using Setup.....	46
5.1.3 Getting Help.....	47
5.1.4 Unable to Reboot after Configuration Changes.....	47
5.1.5 BIOS Menu Bar.....	47
5.2 MAIN.....	48
5.3 ADVANCED.....	49
5.3.1 Trusted Computing.....	50
5.3.2 ACPI Settings.....	51
5.3.3 F81866 Super IO Configuration.....	52
5.3.3.1 Serial Port n Configuration.....	52
5.3.4 iWDD H/W Monitor.....	57

## DRPC-130-AL Embedded System

5.3.5 USB Configuration.....	58
5.3.6 CPU Configuration.....	59
5.3.7 RTC Wake Settings.....	61
5.3.8 Power Saving Configuration.....	62
5.3.9 Serial Port Console Redirection.....	63
5.3.9.1 Legacy Console Redirection Settings.....	65
5.3.10 IEI Feature.....	66
5.4 CHIPSET.....	67
5.4.1 North Bridge.....	68
5.4.1.1 Intel IGD Configuration.....	69
5.4.1.2 LCD Control.....	71
5.4.2 South Bridge.....	72
5.4.2.1 HD-Audio Configuration.....	73
5.4.2.2 PCI Express Configuration.....	74
5.4.2.3 SATA Configuration.....	77
5.5 SECURITY.....	78
5.6 BOOT.....	79
5.7 SAVE & EXIT.....	81
<b>6 INTERFACE CONNECTORS.....</b>	<b>83</b>
6.1 PERIPHERAL INTERFACE CONNECTORS.....	84
6.2 INTERNAL PERIPHERAL CONNECTORS.....	85
6.2.1 Battery Connector (BT1).....	86
6.2.2 CPU Fan Connector (CPU_FAN1).....	86
6.2.3 I <sup>2</sup> C Connector (I2C1).....	86
6.2.4 SATA Connector (SATA1).....	87
6.2.5 USB 2.0 Connector (USB2-2).....	87
6.2.6 SPI Flash Connector (J_SPI1).....	87
6.2.7 SPI Flash Connector - EC (J_SPI2).....	88
6.2.8 TPM Connector (TPM1).....	88
<b>A REGULATORY COMPLIANCE.....</b>	<b>89</b>
<b>B SAFETY PRECAUTIONS.....</b>	<b>94</b>
B.1 SAFETY PRECAUTIONS.....	95
B.1.1 General Safety Precautions.....	95

<i>B.1.2 Anti-static Precautions</i> .....	96
<i>B.1.3 Explanation of Graphical Symbols</i> .....	96
<i>B.1.4 Product Disposal</i> .....	97
<b>B.2 MAINTENANCE AND CLEANING PRECAUTIONS</b> .....	98
<i>B.2.1 Maintenance and Cleaning</i> .....	98
<i>B.2.2 Cleaning Tools</i> .....	98
<b>C DIGITAL I/O INTERFACE</b> .....	<b>99</b>
<b>D WATCHDOG TIMER</b> .....	<b>102</b>
<b>E ERROR BEEP CODE</b> .....	<b>105</b>
E.1 PEI BEEP CODES.....	106
E.2 DXE BEEP CODES .....	106
<b>F HAZARDOUS MATERIALS DISCLOSURE</b> .....	<b>107</b>



# List of Figures

Figure 1-1: DRPC-130-AL Series .....	2
Figure 1-2: DRPC-130-AL Front Panel .....	4
Figure 1-3: DRPC-130-AL Top Panel .....	5
Figure 1-4: Physical Dimensions (millimeters) .....	8
Figure 3-1: Internal Access Panel Retention Screws .....	15
Figure 3-2: SO-DIMM Slot Location .....	16
Figure 3-3: SO-DIMM Module Installation .....	16
Figure 3-4: HDD Installation .....	17
Figure 3-5: PCIe Mini Slot Location (MPCIE1) .....	18
Figure 3-6: mSATA and PCIe Mode Select Switch Location .....	19
Figure 3-7: D-sub Hex Screws and Front Panel Bracket Screws .....	20
Figure 3-8: Terminal Block Screws and Top Panel Bracket Screws .....	20
Figure 3-9: Motherboard Retention Screw Locations .....	20
Figure 3-10: PCIe Mini Slot Location .....	21
Figure 3-11: Removing the Standoff for Half-size PCIe Mini Card .....	22
Figure 3-12: Removing the Retention Screw .....	22
Figure 3-13: Inserting the Full-size PCIe Mini Card into the Slot at an Angle .....	22
Figure 3-14: Securing the Full-size PCIe Mini Card .....	23
Figure 3-15: Removing the Screw .....	23
Figure 3-16: Inserting the Half-size PCIe Mini Card into the Slot at an Angle .....	24
Figure 3-17: Securing the Half-size PCIe Mini Card .....	24
Figure 3-18: Knockout Holes for Wireless Antenna .....	26
Figure 3-19: WLAN PCIe Mini Card Slot Location .....	26
Figure 3-20: Removing the Retention Screw .....	27
Figure 3-21: Inserting the WLAN Module .....	27
Figure 3-22: Securing WLAN Module and Connecting RF Cables .....	28
Figure 3-23: Securing SMA Connector and External Antenna Installation .....	28
Figure 3-24: RJ-45 Ethernet Connector .....	32
Figure 3-25: AT/ATX Switch Location .....	32
Figure 3-26: DIN Rail Mounting Bracket Installation .....	33

**Figure 3-27: Attach the Mounting Bracket to the DIN Rail .....34**

**Figure 3-28: Mounting the System.....34**

**Figure 3-29: Power-on.....36**

**Figure 3-30: IEl Resource Download Center.....37**

**Figure 4-1: Clear CMOS Button Location.....43**

**Figure 4-2: TXE Override Jumper Location .....44**

**Figure 6-1: Main Board Layout Diagram (Front Side).....84**

**Figure 6-2: Main Board Layout Diagram (Solder Side).....85**

# List of Tables

Table 1-1: DRPC-130-AL Model Variations .....	3
Table 1-2: Technical Specifications.....	7
Table 3-1: mSATA and PCIe Mode Select Switch Settings .....	19
Table 3-2: PCIe Mini Card Slot – Full Size (MPCIE1) Pinouts.....	25
Table 3-3: PCIe Mini Card Slot – Half Size (MPCIE2) Pinouts .....	29
Table 3-4: CAN Bus Connector Pinouts .....	30
Table 3-5: Digital IO Connector Pinouts.....	30
Table 3-6: RS-232/422/485 Connector Pinouts .....	31
Table 3-7: LAN1 Pinouts .....	31
Table 3-8: LAN2 Pinouts .....	31
Table 3-9: RJ-45 Ethernet Connector LEDs .....	32
Table 3-10: 3-pin Power Terminal Block Pinouts .....	35
Table 4-1: TXE Override Jumper Settings.....	44
Table 5-1: BIOS Navigation Keys .....	47
Table 5-2: BIOS Options and Configured USB Ports.....	73
Table 6-1: Peripheral Interface Connectors .....	86
Table 6-2: Battery Connector (BT1) Pinouts.....	86
Table 6-3: CPU Fan Connector (CPU_FAN1) Pinouts.....	86
Table 6-4: I <sup>2</sup> C Connector (I2C1) Pinouts.....	86
Table 6-5: SATA 3Gb/s Connector (SATA1) Pinouts .....	87
Table 6-6: USB 2.0 Connector (USB2-2) Pinouts.....	87
Table 6-7: SPI Flash Connector (J_SPI1) Pinouts .....	87
Table 6-8: SPI Flash Connector - EC (J_SPI2) Pinouts.....	88
Table 6-9: TPM Connector (TPM1) Pinouts .....	88



Chapter

1

# Introduction

---



## 1.1 Overview



**Figure 1-1: DRPC-130-AL Series**

The DRPC-130-AL fanless embedded system is powered by the Intel® Atom® x5-E3930 processor. It is designed for harsh environment applications, and supports DIN rail mounting method.

The DRPC-130-AL accepts a wide range of DC power input (12 V ~ 24 V), allowing it to be powered anywhere. Four USB 3.2 Gen 1 (5Gb/s), two GbE, four RS-232/422/485, one 8-bit digital I/O, two HDMI and isolated CAN bus provide rich I/O options for various applications.

## DRPC-130-AL Embedded System

### 1.2 Model Variations

The model variations of the DRPC-130-AL are listed below.

Model No.	Pre-installed Memory
DRPC-130-AL-E1	N/A
DRPC-130-AL-E1/4GB	4 GB DDR3L SO-DIMM

**Table 1-1: DRPC-130-AL Model Variations**

### 1.3 Features

The DRPC-130-AL features are listed below:

- Fanless design
- Intel® Atom® x5-E3930 processor 1.3GHz (up to 1.8 GHz, dual-core)
- Supports DDR3L SO-DIMM (system max. 8 GB)
- Supports one mSATA and one 2.5" SATA HDD
- Wide range DC power input (12 V ~ 24 V)
- Extended temperature fanless design supports -20°C ~ 60°C (with SSD)
- Two PCIe Mini card slots
- Four RS-232/422/485 serial interfaces
- 8-bit digital I/O (4-bit output, 4-bit input)
- Supports two GbE, four USB 3.2 Gen 1 (5 Gb/s) and two HDMI 1.4b
- Low power consumption
- DIN rail mounting support
- RoHS compliant

## 1.4 Front Panel

The DRPC-130-AL front panel contains:

- 1 x DB-9 supporting 2-port isolated CAN bus
- 1 x 8-bit digital I/O
- 2 x RJ-45 Gigabit LAN ports
- 4 x RS-232/422/485 serial ports
- 4 x USB 3.2 Gen 1 (5Gb/s) ports
- 1 x Power LED (green)
- 1 x HDD LED (yellow)

The overview of the front panels is shown in **Figure 1-2**.

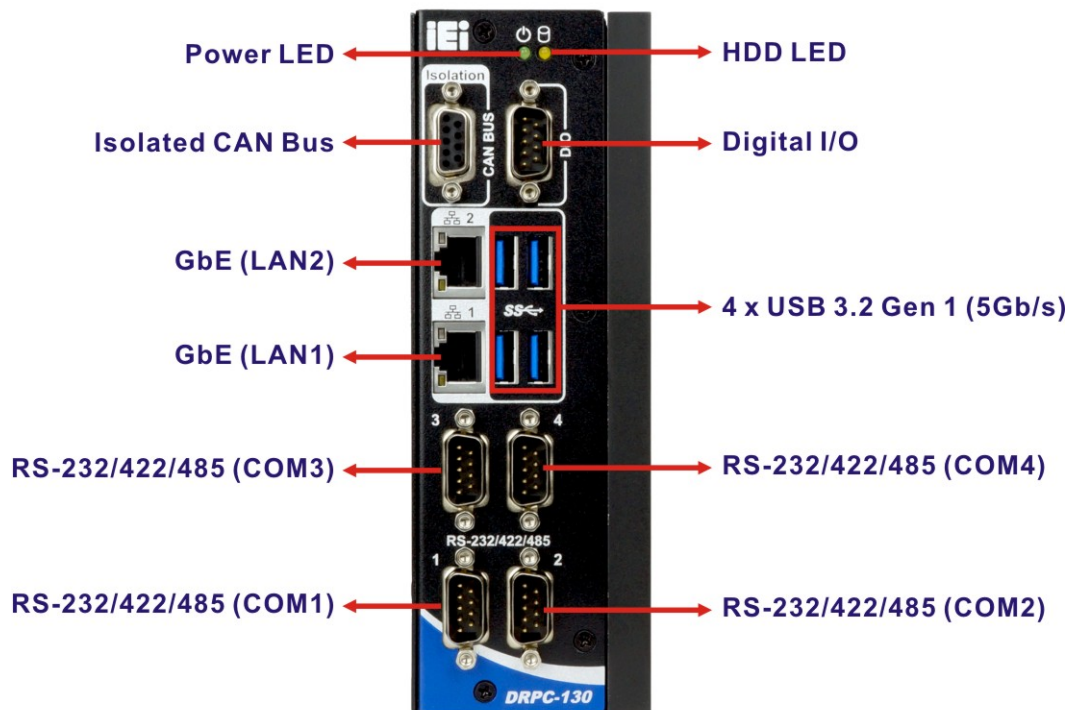

**Figure 1-2: DRPC-130-AL Front Panel**

## DRPC-130-AL Embedded System

### 1.5 Top Panel

The DRPC-130-AL top panel contains:

- 1 x 12 V ~ 24 V DC power terminal block
- 1 x Earth ground connector
- 1 x PS-ON connector
- 2 x HDMI connector
- 1 x Power button
- 1 x Reset button
- 1 x AT/ATX power switch

An overview of the top panel is shown in **Figure 1-3** below.

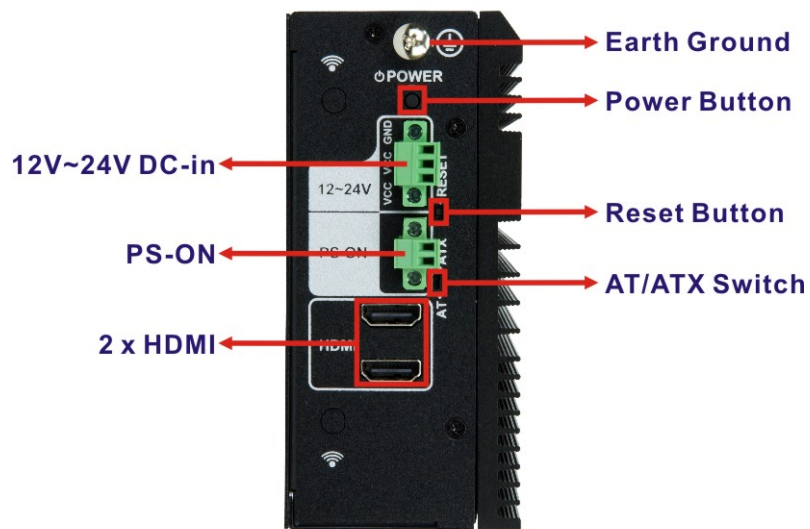

**Figure 1-3: DRPC-130-AL Top Panel**

## 1.6 Technical Specifications

The DRPC-130-AL technical specifications are listed in **Table 1-2**.

<b>System</b>	
<b>CPU (SoC)</b>	Intel® Atom® x5-E3930 processor 1.3GHz (up to 1.8 GHz, dual-core, TDP=6.5W)
<b>Memory</b>	One 204-pin DDR3L SO-DIMM slot (system max. 8 GB) (DRPC-130-AL-E1/4GB SKU is pre-installed with 4 GB memory)
<b>Ethernet Controller</b>	Two Intel® I211 GbE controllers
<b>Wireless</b>	802.11a/b/g/n/ac (optional)
<b>Watchdog Timer</b>	Software programmable, support 1~255 sec. system reset
<b>Supported OS</b>	Microsoft Windows 10 / Linux
<b>Storage</b>	
<b>HDD</b>	One 2.5" SATA 6Gb/s HDD/SSD bay
<b>eMMC</b>	1 x eMMC 5.0 support (up to 32 GB, optional)
<b>mSATA</b>	One PCIe Mini full-size card slot for mSATA module
<b>I/O and Indicators</b>	
<b>Ethernet</b>	2 x RJ-45 ports
<b>COM Port</b>	4 x RS-232/422/485 (DB-9)
<b>USB</b>	4 x USB 3.2 Gen 1 (5Gb/s) ports (external) 1 x USB 2.0 pin-header (internal)
<b>Display</b>	Supports resolution up to 3840 x 2160 @ 30 Hz 2 x HDMI 1.4b port
<b>Digital I/O</b>	8-bit, 4-bit input/4-bit output (DB-9)
<b>CAN Bus</b>	1 x DB-9 with 2.5kV isolation protection, supporting 2-port CAN bus
<b>SIM</b>	1 x Internal on-board SIM slot (optional)
<b>TPM</b>	1 x TPM 2.0 (2x10 pin) (optional)



## DRPC-130-AL Embedded System

<b>Interior Expansion</b>	1 x PCIe Mini full-size/half-size card slot (supports mSATA module or WWAN module) 1 x PCIe Mini half-size card slot (reserved for optional Wi-Fi module)
<b>LED Indicators</b>	1 x HDD LED (yellow) 1 x Power LED (green)
<b>Buttons</b>	Power button Reset button
<b>Power</b>	
<b>Power Input</b>	One power connector (3-pin terminal block) 12 V ~ 24 V DC
<b>Remote Power</b>	One PS-ON connector (2-pin terminal block)
<b>AT/ATX Mode</b>	AT/ATX switch
<b>Power Consumption</b>	12 V @ 2.88 A; 24 V @ 1.45 A (Intel® Atom® x5-E3930 CPU with 4 GB 1600 MHz DDR3L memory)
<b>Environmental and Mechanical</b>	
<b>Mounting</b>	DIN rail
<b>Operating Temperature</b>	-20°C~60°C with air flow (with SSD)
<b>Storage Temperature</b>	-40°C~85°C with air flow (with SSD)
<b>Operating Humidity</b>	10%~95%, non-condensing
<b>Storage Humidity</b>	10%~90%, non-condensing
<b>Chassis Construction</b>	Extruded aluminum alloy for fanless support
<b>Operating Shock</b>	Half-sine shock test 5G/11ms, 100 shocks per axis, IEC68-2-27
<b>Operating Vibration</b>	MIL-STD-810G 514.6C-1 (SSD)
<b>Safety</b>	CE/FCC
<b>Weight (Net/Gross)</b>	1.4 kg/2.5 kg
<b>Physical Dimensions</b>	58.75 mm x 130 mm x 174 mm (W x D x H)

Table 1-2: Technical Specifications

### 1.7 Dimensions

The physical dimensions are shown below:

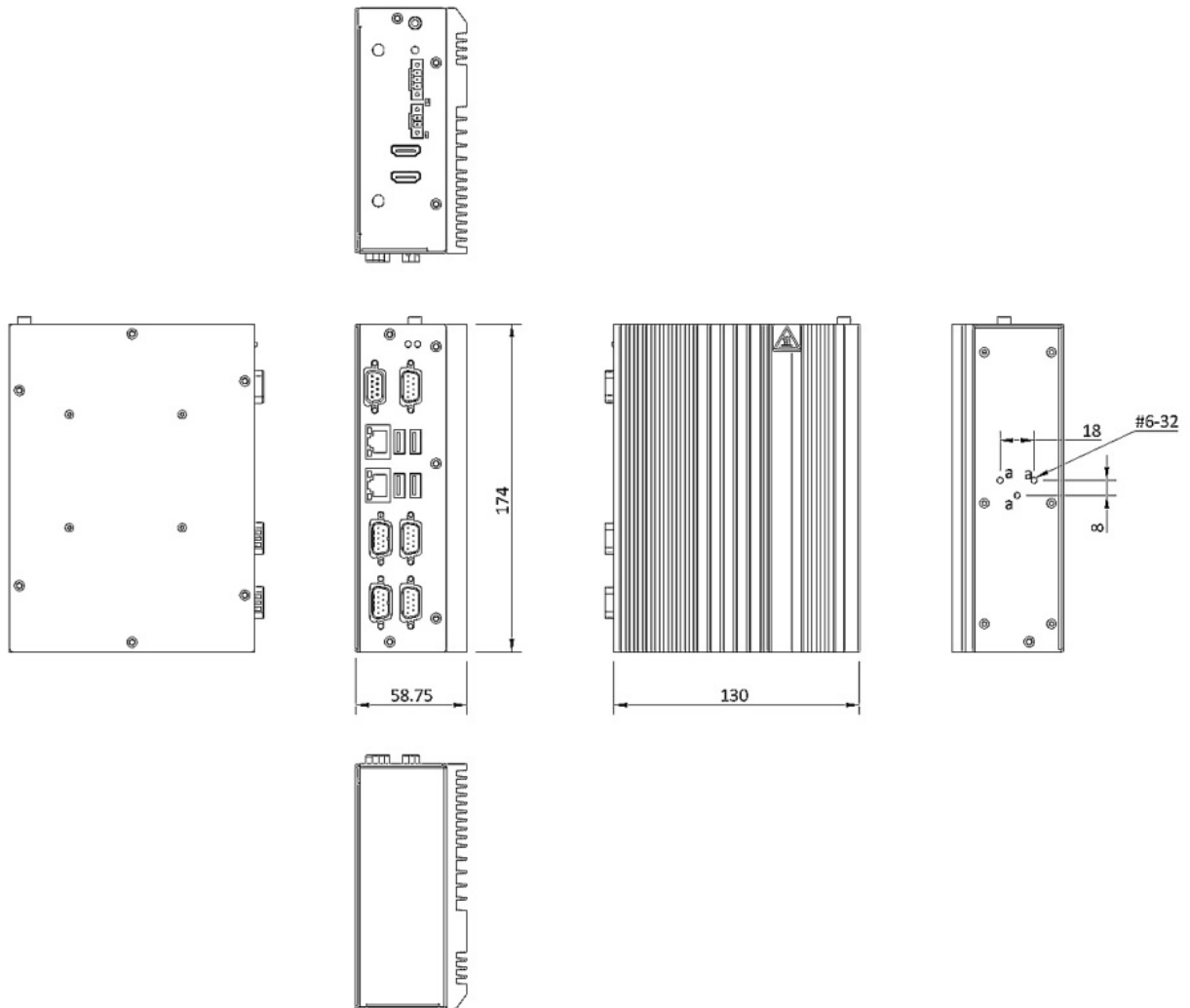

**Figure 1-4: Physical Dimensions (millimeters)**

Chapter

2

# Unpacking

---

## 2.1 Anti-static Precautions

---



### WARNING:

Failure to take ESD precautions during installation may result in permanent damage to the DRPC-130-AL and severe injury to the user.

---

Electrostatic discharge (ESD) can cause serious damage to electronic components, including the DRPC-130-AL. Dry climates are especially susceptible to ESD. It is therefore critical that whenever the DRPC-130-AL or any other electrical component is handled, the following anti-static precautions are strictly adhered to.

- **Wear an anti-static wristband:** Wearing a simple anti-static wristband can help to prevent ESD from damaging the board.
- **Self-grounding:** Before handling the board, touch any grounded conducting material. During the time the board is handled, frequently touch any conducting materials that are connected to the ground.
- **Use an anti-static pad:** When configuring the DRPC-130-AL, place it on an anti-static pad. This reduces the possibility of ESD damaging the DRPC-130-AL.

## 2.2 Unpacking Precautions

When the DRPC-130-AL is unpacked, please do the following:

- Follow the anti-static precautions outlined in **Section 2.1**.
- Make sure the packing box is facing upwards so the DRPC-130-AL does not fall out of the box.
- Make sure all the components shown in **Section 2.3** are present.

## DRPC-130-AL Embedded System





### 2.3 Packing List



#### NOTE:

If some of the components listed in the checklist below are missing, please do not proceed with the installation. Contact the IEI reseller or vendor you purchased the DRPC-130-AL from or contact an IEI sales representative directly. To contact an IEI sales representative, please send an email to [sales@ieiworld.com](mailto:sales@ieiworld.com).







The DRPC-130-AL is shipped with the following components:

Quantity	Item and Part Number	Image
<b>Standard</b>		
1	DRPC-130-AL	
1	DIN rail mounting bracket	
3	Mounting bracket screw	
4	Screw (for securing HDD)	



## 2.4 Optional Items

The following table lists the optional items that can be purchased separately.

Optional	
Power adapter (P/N: 63040-010060-120-RS)	
Power cord, European standard, 1830 mm (P/N: 32702-000200-100-RS)	
Power cable, DC jack to 3-pin terminal block, 200 mm (P/N: 32102-026500-100-RS)	
Wireless kit (P/N: EMB-WIFI-KIT01-R20)	
20-pin Infineon TPM 2.0 module, software management tool, firmware v5.5 (P/N: TPM-IN02-R20)	
OS Image with Windows® 10 IoT Enterprise Entry 64-bit for DRPC-130-AL Series, with DVD-ROM, RoHS (P/N: DRPC-130-W10E64-E-R10)	

Chapter

3

# Installation

---

### 3.1 Installation Precautions

During installation, be aware of the precautions below:

- **Read the user manual:** The user manual provides a complete description of the DRPC-130-AL, installation instructions and configuration options.
- **DANGER! Disconnect Power:** Power to the DRPC-130-AL must be disconnected during the installation process. Failing to disconnect the power may cause severe injury to the body and/or damage to the system.
- **Qualified Personnel:** The DRPC-130-AL must be installed and operated only by trained and qualified personnel. Maintenance, upgrades, or repairs may only be carried out by qualified personnel who are familiar with the associated dangers.
- **Air Circulation:** Make sure there is sufficient air circulation when installing the DRPC-130-AL. The DRPC-130-AL's cooling vents must not be obstructed by any objects. Blocking the vents can cause overheating of the DRPC-130-AL. Leave at least 5 cm of clearance around the DRPC-130-AL to prevent overheating.
- **Grounding:** The DRPC-130-AL should be properly grounded. The voltage feeds must not be overloaded. Adjust the cabling and provide external overcharge protection per the electrical values indicated on the label attached to the back of the DRPC-130-AL.

#### 3.1.1 High Surface Temperature



#### **WARNING:**

Some surfaces of the equipment may become hot during operation.

The surface temperature may be up to several tens of degrees hotter than the ambient temperature. Under these circumstances, the equipment needs to be protected against accidental contact.

---

The equipment is intended for installation in a RESTRICTED ACCESS LOCATION.

## DRPC-130-AL Embedded System

- Access can only be gained by SERVICE PERSONS or by USERS who have been instructed about the reasons for the restrictions applied to the location and about any precautions that shall be taken.
- Access is through the use of a TOOL or lock and key, or other means of security, and is controlled by the authority responsible for the location.

### 3.2 Internal Access Panel Removal

Before installing or maintaining the internal components, the internal access panel must be removed from the DRPC-130-AL. Follow the steps below to complete the task.

**Step 1:** Remove the six retention screws indicated in **Figure 3-1**.

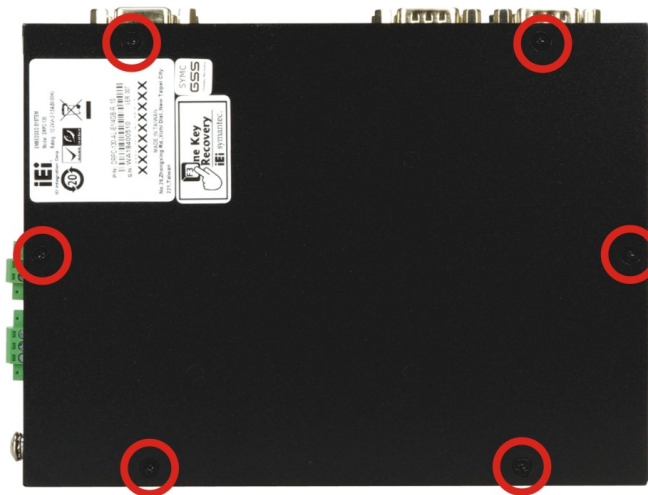

**Figure 3-1: Internal Access Panel Retention Screws**

**Step 2:** Lift the panel. A SATA cable is attached inside the panel. Be gentle when lifting the panel (**Figure 3-1**).

**Step 3:** Remove the tape that attaches the cable to the panel to detach the SATA cable.

### 3.3 SO-DIMM Installation (Optional)

To install the SO-DIMM module, please follow the steps below.

**Step 1:** Remove the internal access panel from the DRPC-130-AL. Please follow the instruction described in **Section 3.2**.

**Step 2:** Locate the SO-DIMM slot on the motherboard.

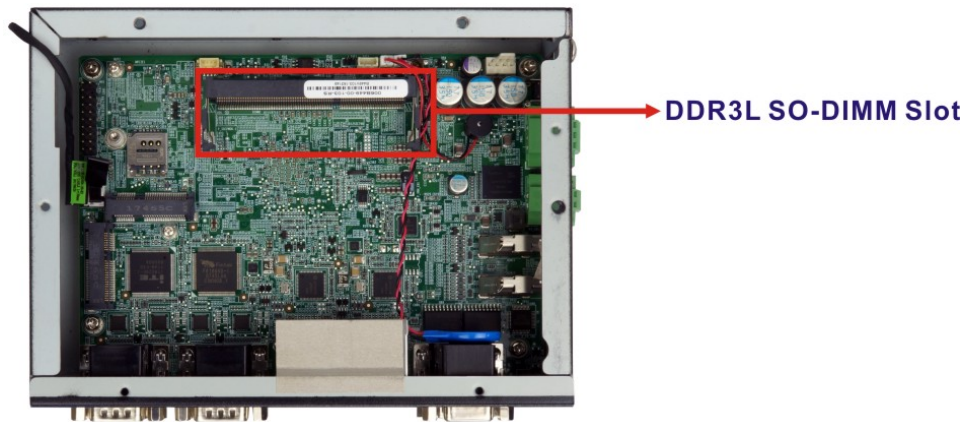

Figure 3-2: SO-DIMM Slot Location

**Step 3:** Install a SO-DIMM module by pushing it into the socket at an angle (**Figure 3-3**).

**Step 4:** Gently push the rear of the SO-DIMM module down (**Figure 3-3**). The spring retainer clips clip into place and secure the SO-DIMM module in the socket.

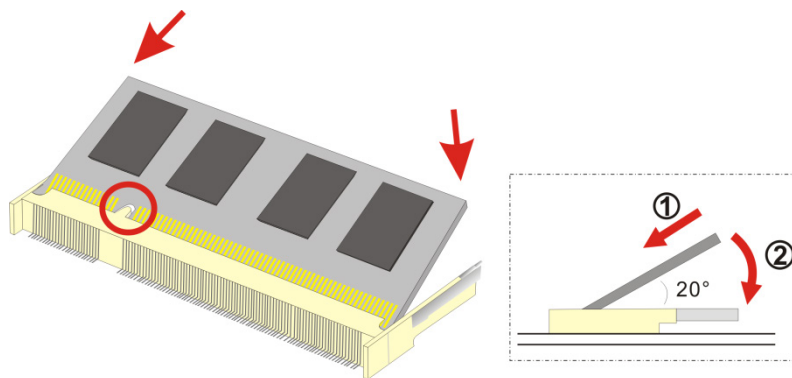

Figure 3-3: SO-DIMM Module Installation

**Step 4:** Push the SO-DIMM module until it engages and the white plastic end clips click into place. Make sure the end clips are fully secured after installation.



## DRPC-130-AL Embedded System

### 3.4 HDD Installation



#### WARNING:

Please install a solid state drive (SSD) when the DRPC-130-AL is used in a harsh environment with extreme shock and vibration.

It is recommended to use 2.5" HDD/SSD as the main system drive.

The DRPC-130-AL allows installation of one 2.5" HDD/SSD. To install a HDD into the system, please follow the steps below.

- Step 1:** Remove the internal access panel from the DRPC-130-AL. Please follow the instruction described in **Section 3.2**.
- Step 2:** Install the HDD into the bracket on the internal access panel, and secure the HDD with four retention screws (**Figure 3-4**).
- Step 3:** Connect the SATA cable from the motherboard to the rear of the HDD (**Figure 3-4**).

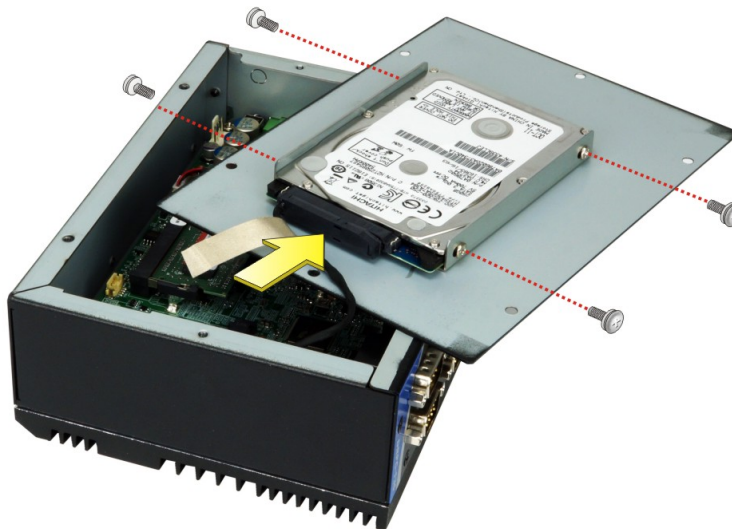

Figure 3-4: HDD Installation

**Step 4:** Stick the conductive adhesive tape attached on the SATA cable to the inside surface of the internal access panel.



**WARNING:**

The conductive adhesive tape must be attached properly and securely. Failure to do so may cause damage to the motherboard.

---

**Step 5:** Replace and secure the internal access panel to the system.

### 3.5 PCIe Mini Card Installation (mSATA or WWAN)

The DRPC-130-AL has one full-size/half-size PCIe Mini slot (MPCIE1) on the motherboard for mSATA SSD or WWAN module installation. Refer to the instructions described in the following sections for how to set the mode and how to install a PCIe Mini card in the slot.

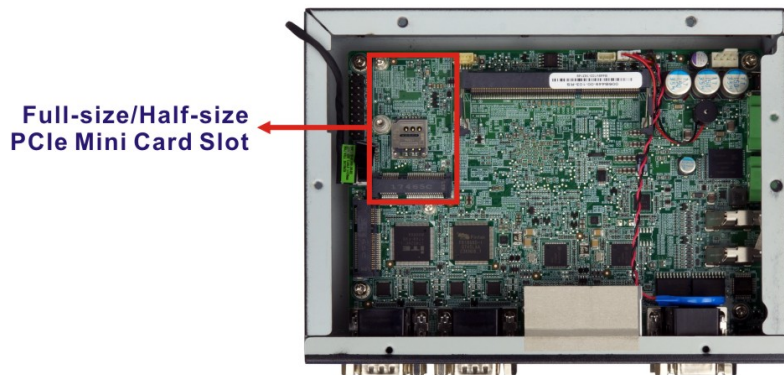

**Figure 3-5: PCIe Mini Slot Location (MPCIE1)**



**NOTE:**

The mode of this slot is set to mSATA by default. To change it to the PCIe mode, please refer to **Section 3.5.1** below.

---

## DRPC-130-AL Embedded System

### 3.5.1 mSATA/PCIe Mode Selection

Use the mSATA and PCIe mode select switch (MSATA\_CN1) to set the mode of the full-size/half-size PCIe Mini slot (MPCIE1). The switch settings are shown in **Table 3-1**.

Setting	Description
Short A-B	Set MPCIE1 as mSATA interface (Default)
Short B-C	Set MPCIE1 as PCIe Mini interface

**Table 3-1: mSATA and PCIe Mode Select Switch Settings**

The location of the mSATA and PCIe mode select switch is shown in **Figure 3-6** below.

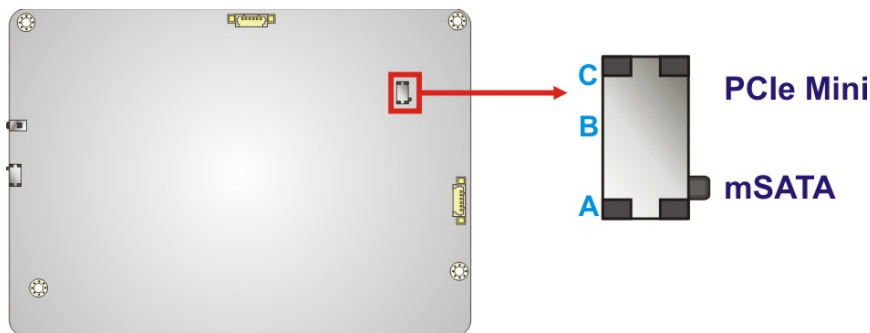

**Figure 3-6: mSATA and PCIe Mode Select Switch Location**

This switch is located on the rear side of the motherboard. To access the switch, please follow the instruction below to remove the motherboard from the DRPC-130-AL.

**Step 1:** Remove the internal access panel from the DRPC-130-AL. See **Section 3.2**.

**Step 2:** Remove the front panel bracket by removing all of the hex screws (circled in red) of the D-sub connectors, and the five retention screws (circled in yellow).

See **Figure 3-7**.



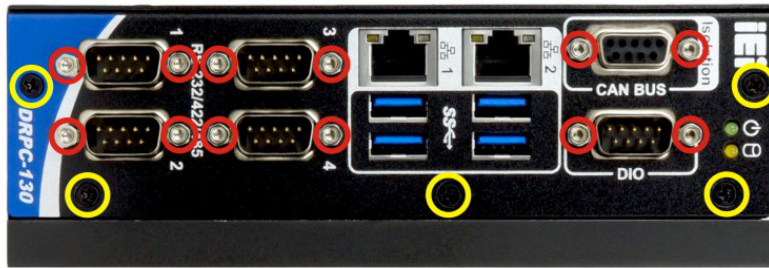

**Figure 3-7: D-sub Hex Screws and Front Panel Bracket Screws**

**Step 3:** Remove the top panel bracket. Loosen the screws (circled in red) to remove the two terminal block covers. Remove the three retention screws circled in yellow. See **Figure 3-8**.

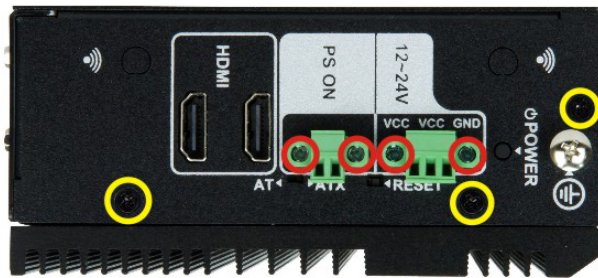

**Figure 3-8: Terminal Block Screws and Top Panel Bracket Screws**

**Step 4:** Remove the four motherboard retention screws.

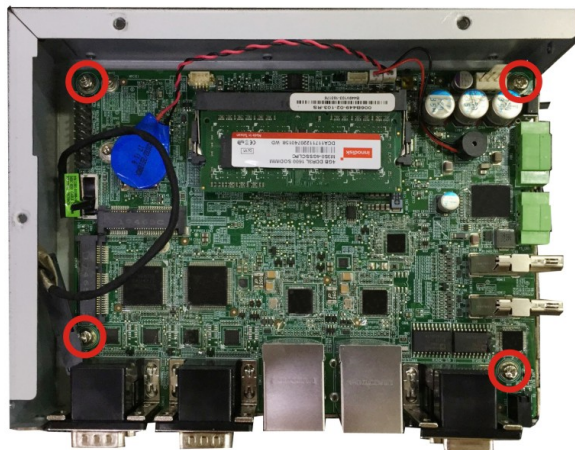

**Figure 3-9: Motherboard Retention Screw Locations**

## DRPC-130-AL Embedded System

**Step 5:** Gently lift the motherboard and remove it from the system chassis.

### 3.5.2 Full-size PCIe Mini Card Installation

To install a full-size PCIe Mini module, follow the instructions below.

**Step 1:** Remove the internal access panel from the DRPC-130-AL. See **Section 3.2**.

**Step 2:** Locate the PCIe Mini slot on the motherboard (Figure 3-10).

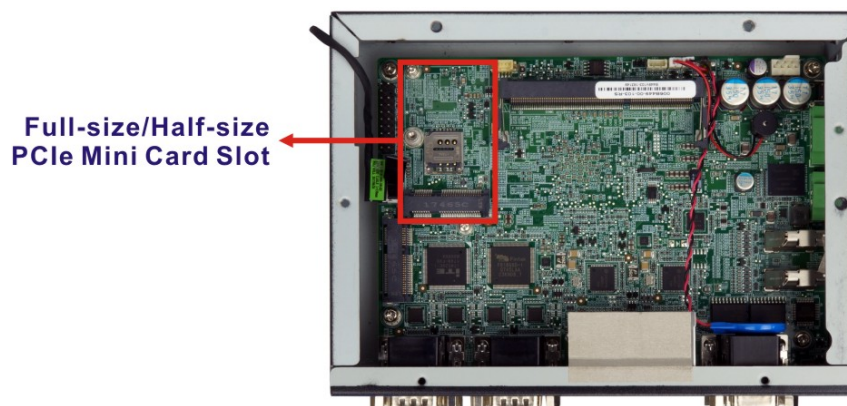

**Figure 3-10: PCIe Mini Slot Location**

**Step 3:** Remove the standoff for a half-size PCIe Mini card as shown in **Figure 3-11** to avoid interference of the board circuit.

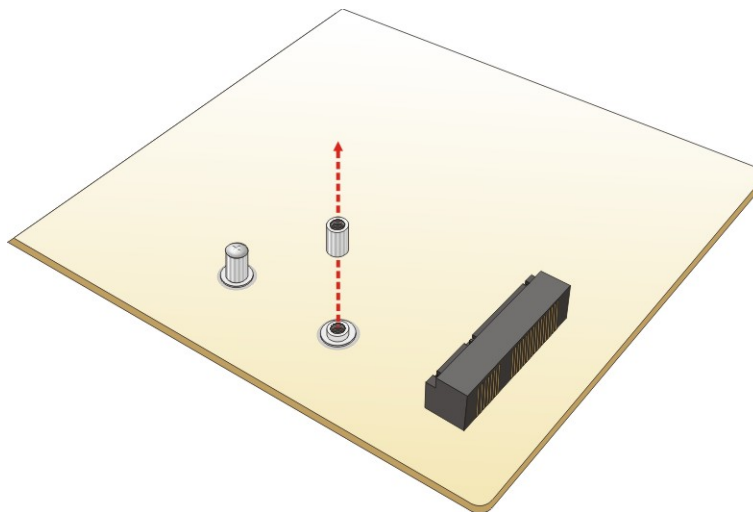



**Figure 3-11: Removing the Standoff for Half-size PCIe Mini Card**

**Step 4:** Remove the retention screw as shown in **Figure 3-12**.

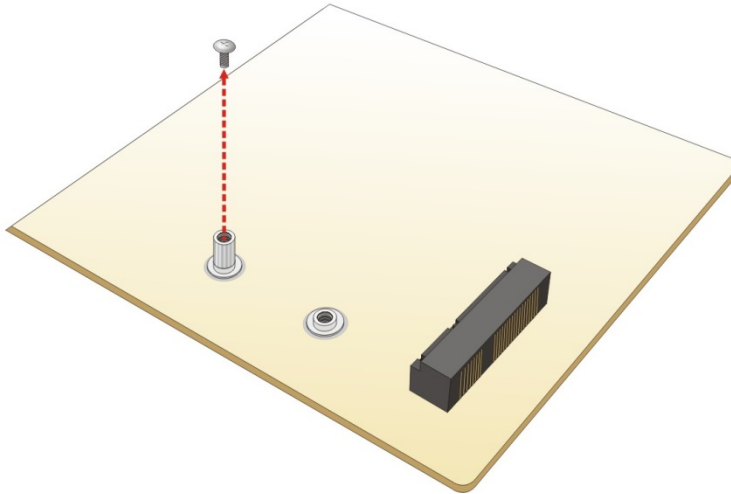

**Figure 3-12: Removing the Retention Screw**

**Step 5:** Line up the notch on the card with the notch on the slot. Slide the PCIe Mini card into the socket at an angle of about 20° (**Figure 3-13**).

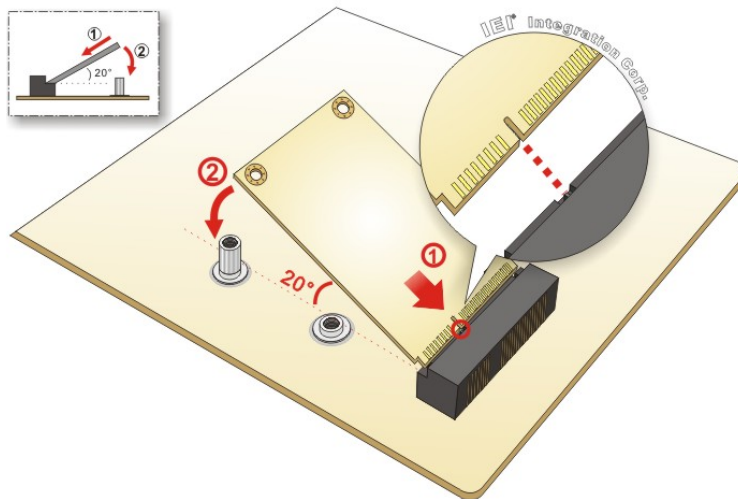

**Figure 3-13: Inserting the Full-size PCIe Mini Card into the Slot at an Angle**

**Step 6:** Secure the full-size PCIe Mini card with the retention screw previously removed (**Figure 3-14**).

## DRPC-130-AL Embedded System

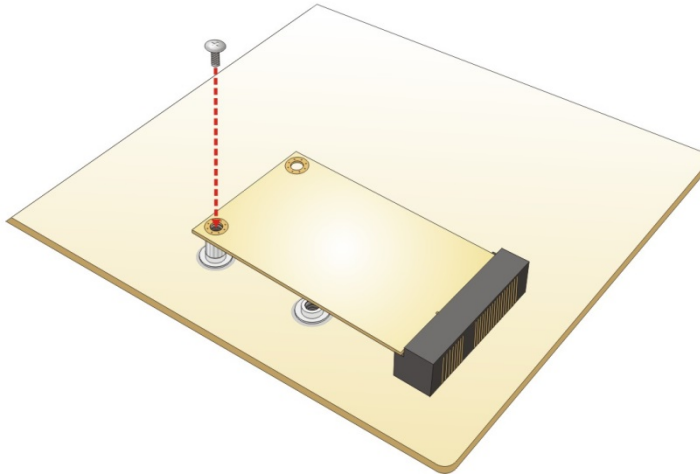

Figure 3-14: Securing the Full-size PCIe Mini Card

### 3.5.3 Half-size PCIe Mini Card Installation

The PCIe Mini slot (MPCIE1) also allows installation of a half-size PCIe Mini card. To install a half-size PCIe Mini card, please follow the steps below.

**Step 1:** Remove the retention screw as shown in **Figure 3-15**.

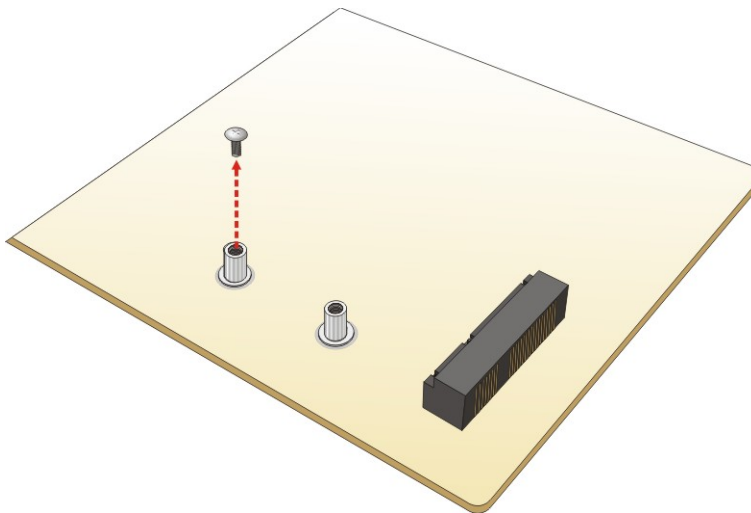
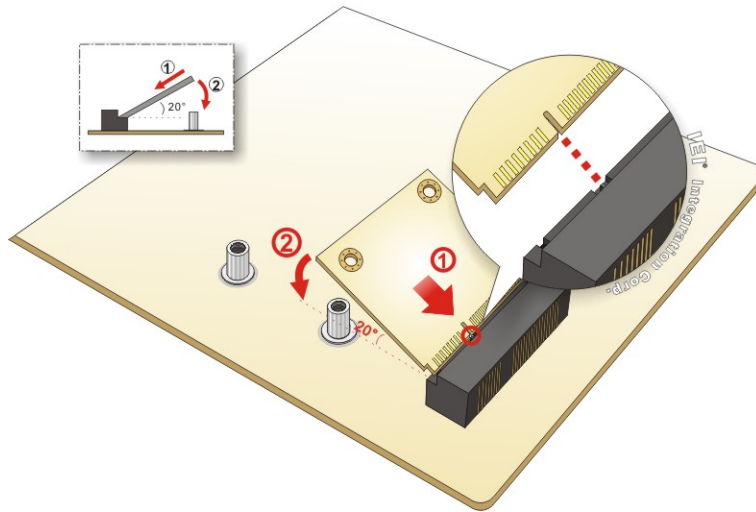

Figure 3-15: Removing the Screw

**Step 2:** Line up the notch on the card with the notch on the slot. Slide the PCIe Mini card into the socket at an angle of about 20° (**Figure 3-16**).



**Figure 3-16: Inserting the Half-size PCIe Mini Card into the Slot at an Angle**

**Step 3:** Secure the half-size PCIe Mini card with the retention screw previously removed (Figure 3-17).

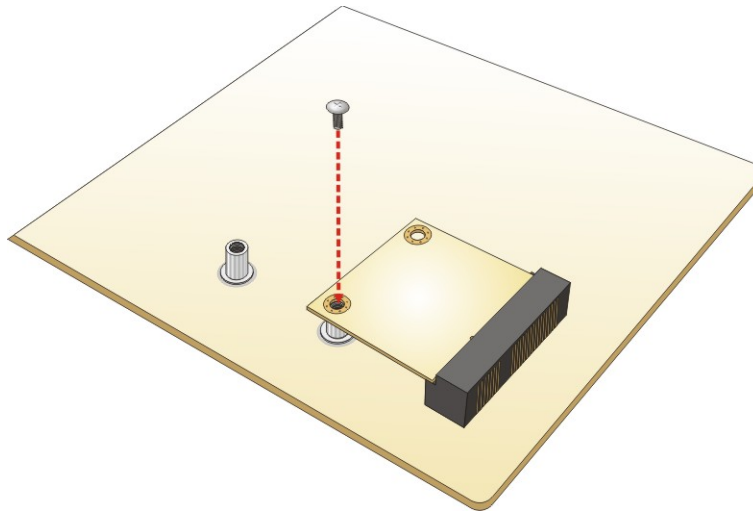

**Figure 3-17: Securing the Half-size PCIe Mini Card**

## DRPC-130-AL Embedded System

### 3.5.4 PCIe Mini Card Slot Pinouts – Full/Half Size (MPCIE1)

The MPCIE1 slot supports USB and PCIe signal for installing mSATA or WWAN modules.

PIN NO.	DESCRIPTION	PIN NO.	DESCRIPTION
1	PCIE_WAKE#	2	VCC3
3	N/C	4	GND
5	N/C	6	VCC1.5
7	CLKREQ#	8	N/C
9	GND	10	N/C
11	REFCLK0-	12	N/C
13	REFCLK0+	14	N/C
15	GND	16	N/C
17	N/C	18	GND
19	N/C	20	N/C
21	GND	22	PERST#
23	PERn0	24	VCC3_AUX
25	PERp0	26	GND
27	GND	28	VCC1.5
29	GND	30	SMBCLK
31	PETn0	32	SMBDATA
33	PETp0	34	GND
35	GND	36	USB2_P7_D-
37	GND	38	USB2_P7_D+
39	VCC3_AUX	40	GND
41	VCC3_AUX	42	N/C
43	N/C	44	N/C
45	N/C	46	N/C
47	N/C	48	VCC1.5
49	N/C	50	GND
51	RESERVED	52	VCC3

**Table 3-2: PCIe Mini Card Slot – Full Size (MPCIE1) Pinouts**



### 3.6 Wireless LAN Module Installation (Optional)

To install the optional wireless LAN (WLAN) module, please follow the steps below.

**Step 1:** Remove the internal access panel from the DRPC-130-AL. Please follow the instruction described in **Section 3.2**.

**Step 2:** Remove the two knockout holes for antenna installation. The two knockout holes are located on the top panel of the DRPC-130-AL as shown below.



**Figure 3-18: Knockout Holes for Wireless Antenna**

**Step 3:** Locate the half-size PCIe Mini slot (**Figure 3-19**).

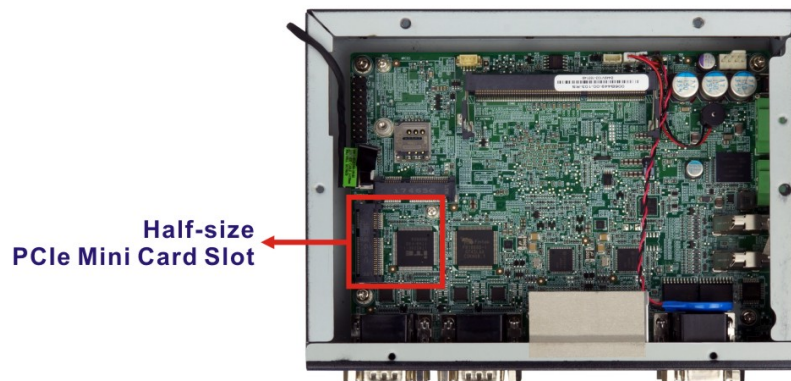
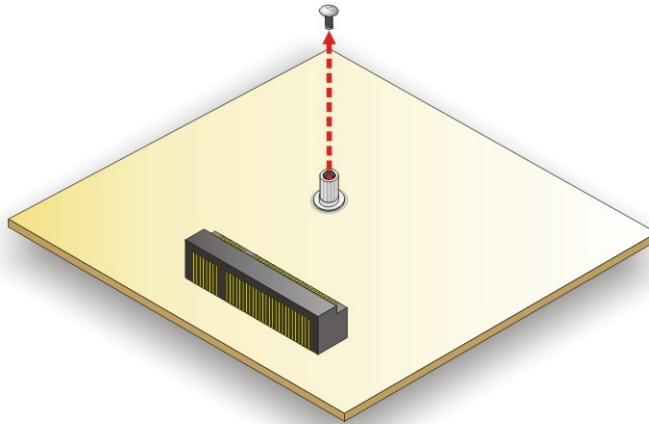

**Figure 3-19: WLAN PCIe Mini Card Slot Location**



## DRPC-130-AL Embedded System

**Step 4:** Remove the retention screw for half-size card installation as shown below.



**Figure 3-20: Removing the Retention Screw**

**Step 5:** Line up the notch on the WLAN module with the notch on the slot. Slide the WLAN module into the slot at an angle of about 20° (**Figure 3-21**).

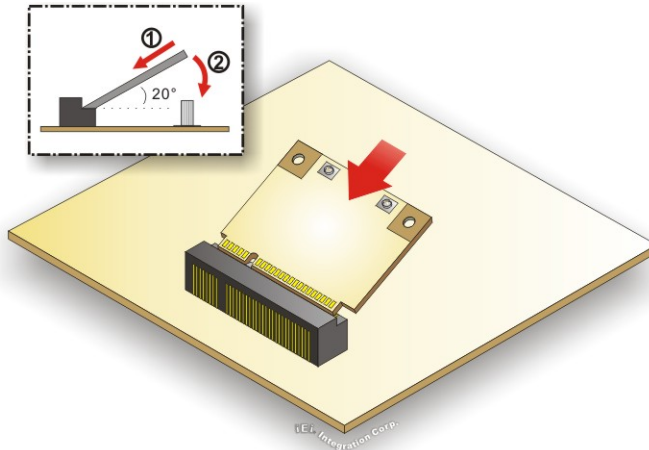

**Figure 3-21: Inserting the WLAN Module**

**Step 6:** Secure the WLAN module with the retention screw previously removed (**Figure 3-22**).

**Step 7:** Connect the two RF cables to the antenna connectors on the WLAN module (**Figure 3-22**).

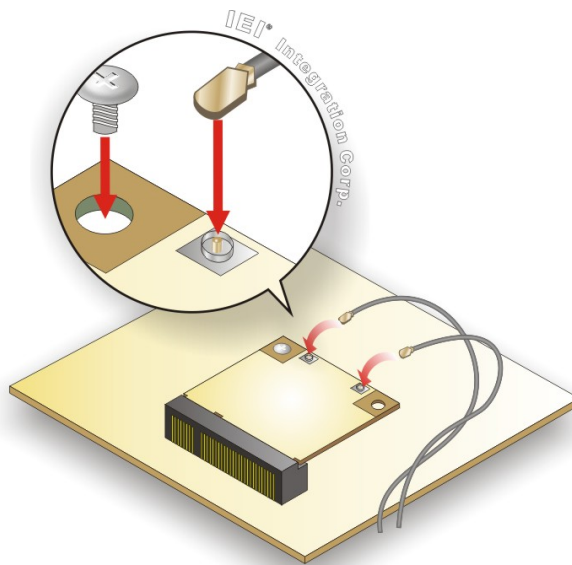

**Figure 3-22: Securing WLAN Module and Connecting RF Cables**

- Step 8:** Remove the nut and washer from the SMA connector at the other end of the RF cable.
- Step 9:** Insert the SMA connector to the antenna connector holes on the rear panel.
- Step 10:** Secure the SMA connector by inserting the washer and tightening it with nut.
- Step 11:** Install the external antenna.

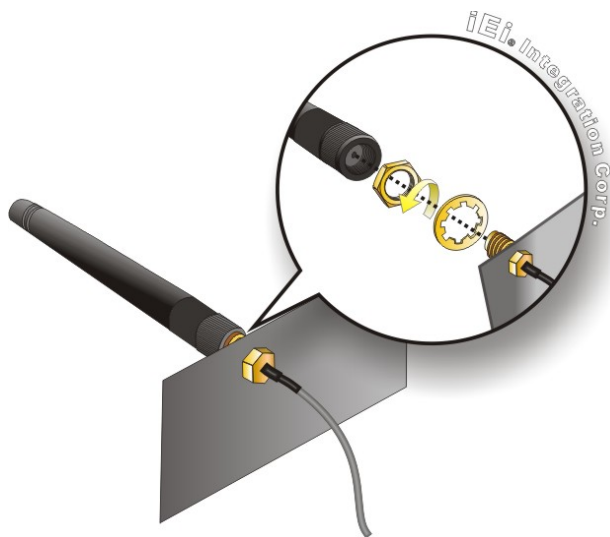

**Figure 3-23: Securing SMA Connector and External Antenna Installation**

## DRPC-130-AL Embedded System

### 3.6.1 PCIe Mini Card Slot Pinouts – Half Size (MPCIE2)

The MPCIE2 slot supports USB and PCIe signal and is reserved for WLAN module installation.

PIN NO.	DESCRIPTION	PIN NO.	DESCRIPTION
1	PCIE_WAKE#	2	VCC3
3	RESERVED	4	GND
5	RESERVED	6	VCC1.5
7	CLKREQ#	8	N/C
9	GND	10	N/C
11	REFCLK1-	12	N/C
13	REFCLK1+	14	N/C
15	GND	16	N/C
17	N/C	18	GND
19	N/C	20	N/C
21	GND	22	PERST#
23	PERn2	24	VCC3_AUX
25	PERp2	26	GND
27	GND	28	VCC1.5
29	GND	30	SMBCLK
31	PETn2	32	SMBDATA
33	PETp2	34	GND
35	GND	36	USB2_P6_D-
37	GND	38	USB2_P6_D+
39	VCC3_AUX	40	GND
41	VCC3_AUX	42	N/C
43	N/C	44	N/C
45	N/C	46	N/C
47	N/C	48	VCC1.5
49	N/C	50	GND
51	RESERVED	52	VCC3

**Table 3-3: PCIe Mini Card Slot – Half Size (MPCIE2) Pinouts**

### 3.7 CAN Bus Connection

The DRPC-130-AL has one CAN bus connector that supports two CAN bus connections. The pinouts for the CAN bus connector are listed in the table below.

Pin	Description	Pin	Description
1	CAN1_GND	6	CAN0_L
2	CAN1_H	7	N/C
3	N/C	8	N/C
4	CAN0_GND	9	CAN1_L
5	CAN0_H		

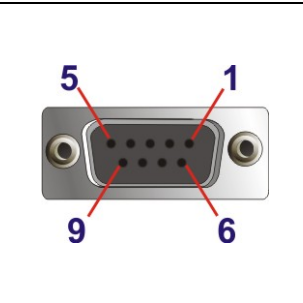
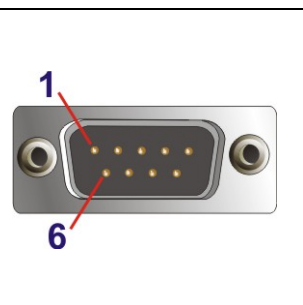

**Table 3-4: CAN Bus Connector Pinouts**

### 3.8 Digital I/O Connection

The digital I/O connector provides programmable input and output for external devices. The digital I/O provides 4-bit output and 4-bit input. The pinouts of the D-sub 9 male connector are listed below.

Pin	Description	Pin	Description
1	DIN0	6	DOUT2
2	DOUT0	7	DIN3
3	DIN1	8	DOUT3
4	DOUT1	9	+V5
5	DIN2		



**Table 3-5: Digital IO Connector Pinouts**

### 3.9 RS-232/422/485 Serial Port Connection

The DRPC-130-AL has four D-sub 9 male connectors for RS-232/422/485 connection. The pinouts of the D-sub 9 connectors are listed below. The RS-232/422/485 mode can be configured through BIOS (refer to **Section 5.3.3**); the default setting is RS-232 mode.

## DRPC-130-AL Embedded System

PIN NO.	RS-232	RS-422	RS-485
1	DCD	TX-	TX-
2	RX	TX+	TX+
3	TX	RX+	
4	DTR	RX-	
5	GND		
6	DSR		
7	RTS		
8	CTS		
9	RI		

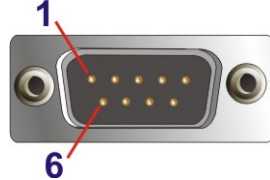

**Table 3-6: RS-232/422/485 Connector Pinouts**

### 3.10 LAN Connection

The LAN connectors allow connection to an external network.

Pin	Description	Pin	Description
1	TRD1P0	5	TRD1P2
2	TRD1N0	6	TRD1N2
3	TRD1P1	7	TRD1P3
4	TRD1N1	8	TRD1N3

**Table 3-7: LAN1 Pinouts**

Pin	Description	Pin	Description
1	TRD2P0	5	TRD2P2
2	TRD2N0	6	TRD2N2
3	TRD2P1	7	TRD2P3
4	TRD2N1	8	TRD2N3

**Table 3-8: LAN2 Pinouts**



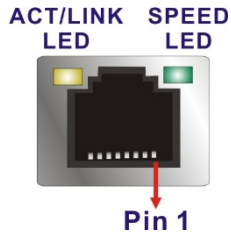

**Figure 3-24: RJ-45 Ethernet Connector**

The RJ-45 Ethernet connector has two status LEDs, one green and one yellow. The green LED indicates activity on the port and the yellow LED indicates the port is linked. See **Table 3-9**.

Activity/Link LED		Speed LED	
STATUS	DESCRIPTION	STATUS	DESCRIPTION
Off	No link	Off	10 Mbps connection
Yellow	Linked	Green	100 Mbps connection
Blinking	TX/RX activity	Orange	1 Gbps connection

**Table 3-9: RJ-45 Ethernet Connector LEDs**

### 3.11 AT/ATX Mode Selection

AT and ATX power modes can both be used on the DRPC-130-AL. The selection is made through an AT/ATX switch on the top panel as shown below (**Figure 3-25**).

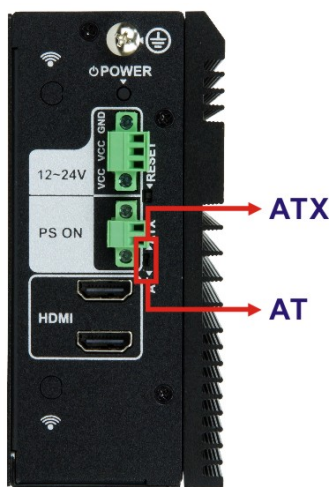

**Figure 3-25: AT/ATX Switch Location**

## DRPC-130-AL Embedded System

### 3.12 DIN Rail Mounting

To mount the DRPC-130-AL embedded system onto a DIN rail, please follow the steps below.

- Step 1:** Attach the supplied DIN rail mounting bracket to the rear panel of the embedded system. Secure the bracket to the embedded system with three retention screws (Figure 3-26).

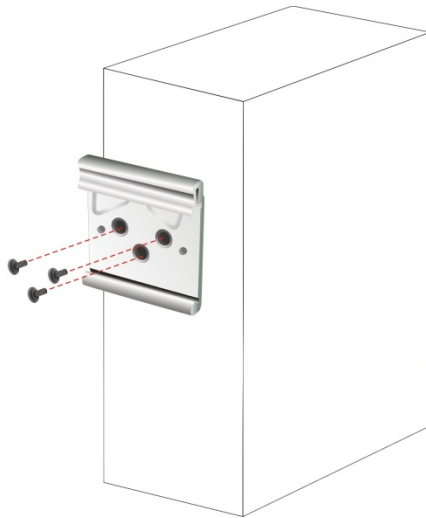

Figure 3-26: DIN Rail Mounting Bracket Installation



**NOTE:**

In the diagrams below, the DIN rail is already installed on a surface or on a chassis.

---

**Step 2:** Attach the upper edge of the mounting bracket to the DIN rail as shown in **Figure 3-27**.

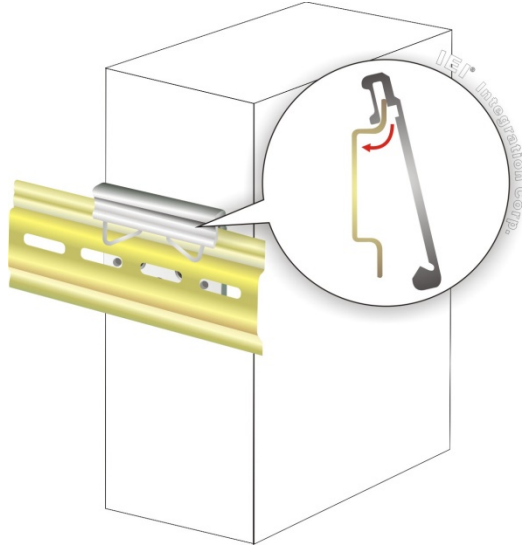

**Figure 3-27: Attach the Mounting Bracket to the DIN Rail**

**Step 3:** Push the system toward the DIN rail until the mounting bracket clips into place firmly (**Figure 3-28**).

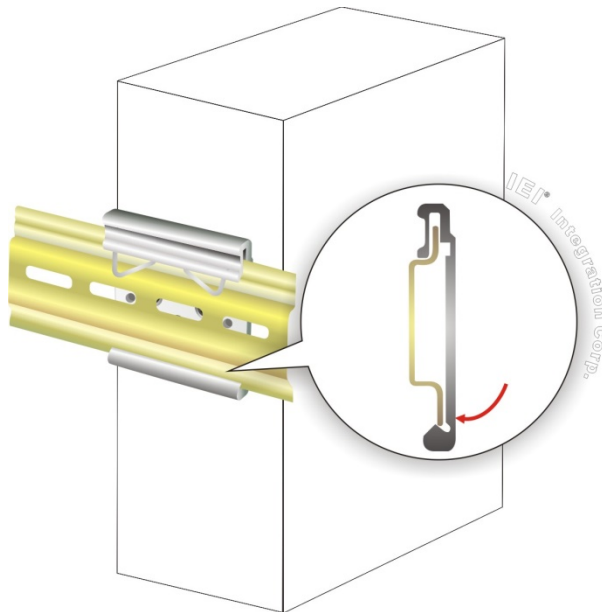

**Figure 3-28: Mounting the System**

## DRPC-130-AL Embedded System

### 3.13 Power-On Procedure

#### 3.13.1 Installation Checklist

**WARNING:**

Make sure a power supply with the correct input voltage is being fed into the system. Incorrect voltages applied to the system may cause damage to the internal electronic components and may also cause injury to the user.

---

To power on the embedded system please make sure of the following:

- The rear surface panel is installed
- All peripheral devices (monitor, serial communications devices etc.) are connected
- The system is securely mounted

#### 3.13.2 Terminal Block Pinouts

The DRPC-130-AL model has a 12 V – 24 V power input terminal block. The terminal block pinouts are shown below. Make sure that the power and ground wires are attached to the correct sockets of the connector.

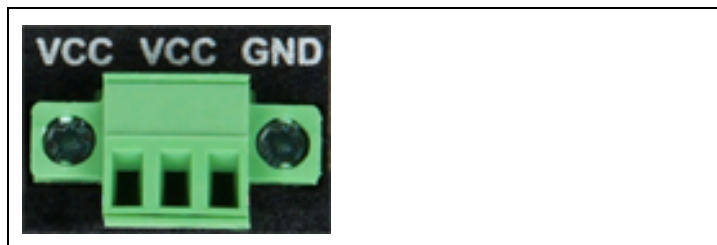
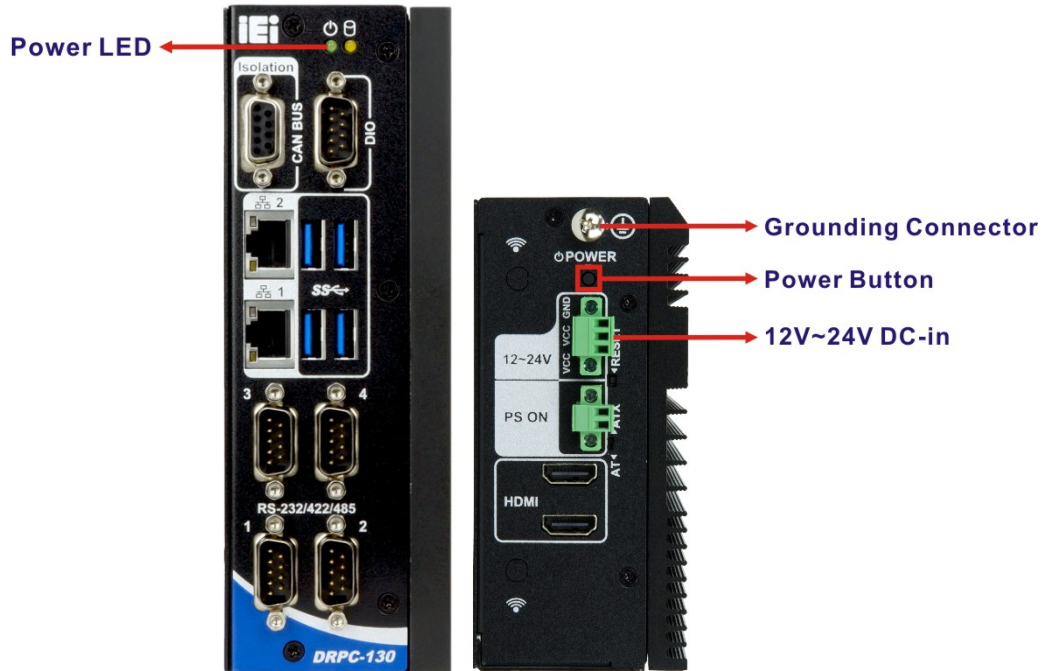

**Table 3-10: 3-pin Power Terminal Block Pinouts**

**3.13.3 Power-on Procedure**

To power-on the DRPC-130-AL please follow the steps below:

- Step 1:** Connect the power source to the power input terminal block.
- Step 2:** Connect the grounding cable to the grounding connector on the top panel of the DRPC-130-AL.
- Step 3:** ATX mode (default): Long press the power button for around 5 seconds until the power LED turns to green.  
AT mode: The system turns on automatically.



**Figure 3-29: Power-on**



## DRPC-130-AL Embedded System

### 3.13.4 PS-ON, 2-pin Terminal Block

The PS-ON connector on the top panel can be used to connect with a remote on/off switch. The pinouts of the PS-ON connector are listed below.

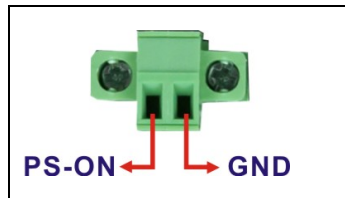

## 3.14 Available Drivers

All the drivers for the DRPC-130-AL are available on IEI Resource Download Center (<https://download.ieiworld.com>). Type DRPC-130-AL and press Enter to find all the relevant software, utilities, and documentation.

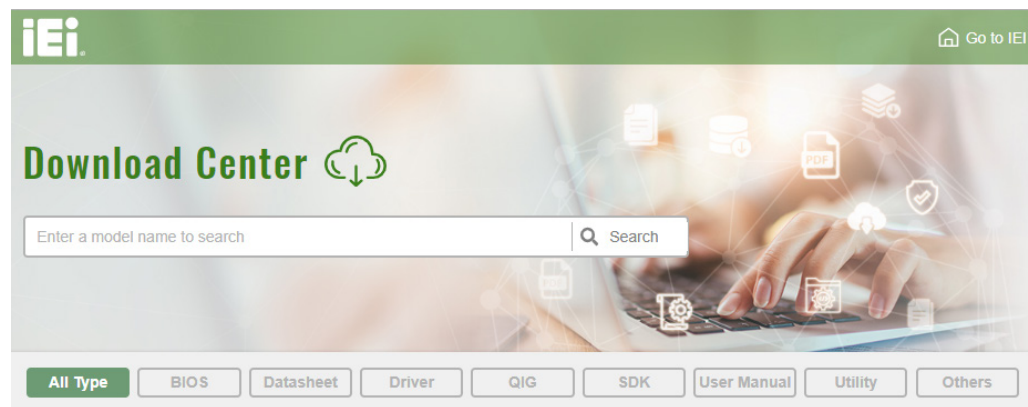

Figure 3-30: IEI Resource Download Center

IEI provides the following drivers for Windows 10 operating system.

- Chipset
- Graphics
- LAN
- Audio
- Serial I/O driver (64-bit only)
- TXE



**NOTE:**

To install software from the downloaded ISO image file in Windows 10, double-click the ISO file to mount it as a virtual drive to view its content.

**3.14.1 Driver Download**

To download drivers from IEI Resource Download Center, follow the steps below.

**Step 1:** Go to <https://download.ieiworld.com>. Type DRPC-130-AL and press Enter.

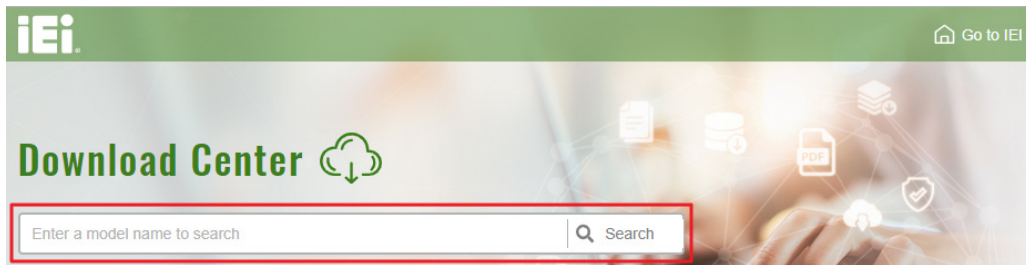

**Step 2:** All product-related software, utilities, and documentation will be listed. You can choose **Driver** to filter the result.

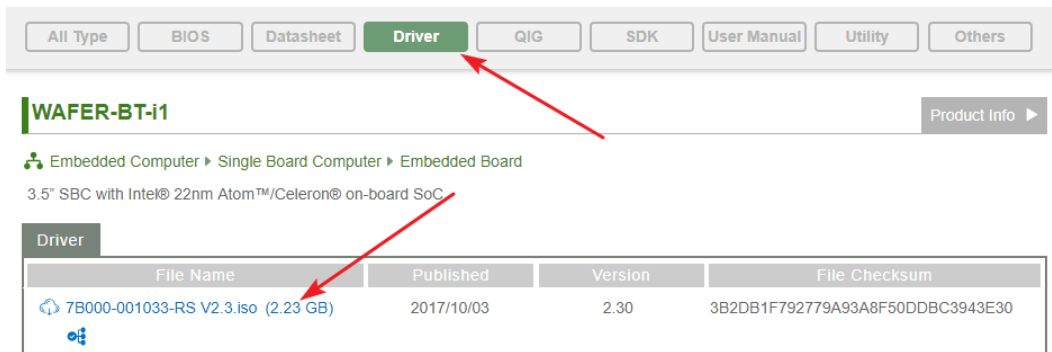

**Step 3:** Click the driver file name on the page and you will be prompted with the following window. You can download the entire ISO file (❶), or click the small arrow to find an individual driver and click the file name to download (❷).

## DRPC-130-AL Embedded System

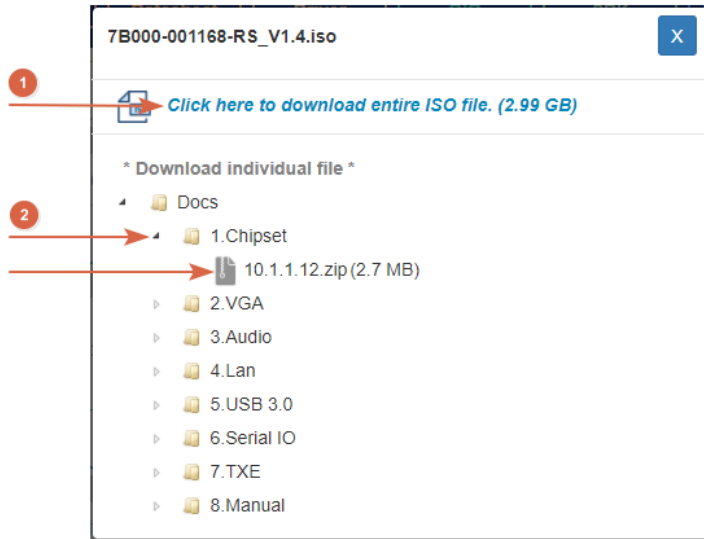

Chapter

**4**

# Troubleshooting and Maintenance

---

## DRPC-130-AL Embedded System

---



### WARNING:

Take Anti-Static precautions whenever maintenance is being carried out on the system components. Failure to take anti-static precautions can cause permanent system damage. For more details on anti-static precautions, please refer to **Section 2.1**.

---

## 4.1 System Maintenance Overview

---



### NOTE:

When doing maintenance operations on the system, please follow the instructions in this chapter. Failure to follow these instructions may lead to personal injury and system damage.

---

To preserve the working integrity of the DRPC-130-AL embedded system, the system must be properly maintained. If embedded system components need replacement, the proper maintenance procedures must be followed to ensure the system can continue to operate normally.

## 4.2 System Troubleshooting

This section provides some simple troubleshooting suggestions.

### 4.2.1 The System Doesn't Turn On

If after turning the system on, there is no power (indicated by the power LED on the front panel not turning on) please do the following:

- Step 1:** Check that the power cable connector is properly connected to the system rear panel.
- Step 2:** Check that the power cable connector is properly plugged into the power source.



**Step 3:** Make sure the power button is turned on.

**Step 4:** Plug the system into a monitor and check to see if anything appears on the screen. If the boot-up screen appears it means the power LED has failed. To fix this problem, contact an IEI sales representative directly.

#### 4.2.2 The System Doesn't Boot Up

If the system doesn't boot up please do the following:

**Step 1:** Check the power is turned on. See **Section 4.2.1** above.

**Step 2:** Make sure the SO-DIMM modules are properly installed.

#### 4.2.3 More Troubleshooting

***Nothing appears on the monitor after booting up the system:*** Make sure the monitor is properly connected to the system and the monitor is connected to a power supply and turned on.



#### **WARNING:**

If all troubleshooting measures have been taken and the system still fails to start, contact the IEI reseller or vendor you purchased the DRPC-130-AL from or contact an IEI sales representative directly. To contact an IEI sales representative, please send an email to [sales@ieiworld.com](mailto:sales@ieiworld.com).

---

### 4.3 Maintenance

To configure the jumper settings, please follow the steps below.

**Step 1:** Remove the internal access panel. See **Section 3.2**.

**Step 2:** Locate the jumper/button on the embedded motherboard.

## DRPC-130-AL Embedded System

**Step 3:** Make the jumper settings in accordance with the settings described and defined in the following sections.

### 4.3.1 Clear CMOS

If the DRPC-130-AL fails to boot due to improper BIOS settings, the clear CMOS button clears the CMOS data and resets the system BIOS information. To do this, push the clear CMOS button for a few seconds.

If the “CMOS Settings Wrong” message is displayed during the boot up process, the fault may be corrected by pressing the F1 to enter the CMOS Setup menu. Do one of the following:

- Enter the correct CMOS setting
- Load Optimal Defaults
- Load Failsafe Defaults.

After having done one of the above, save the changes and exit the CMOS Setup menu.

The clear CMOS button location is shown in **Figure 4-1** below.

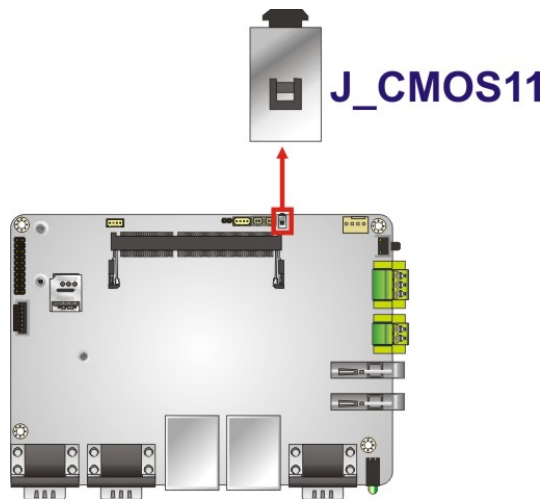

**Figure 4-1: Clear CMOS Button Location**

### 4.3.2 TXE Override Jumper

The TXE Override jumper (J\_TXE1) allows users to enable or disable the TXE firmware update. Refer to **Figure 4-2** and **Table 4-1** for the jumper location and settings.

Setting	Description
Open	Disabled (default)
Short	Enabled

**Table 4-1: TXE Override Jumper Settings**

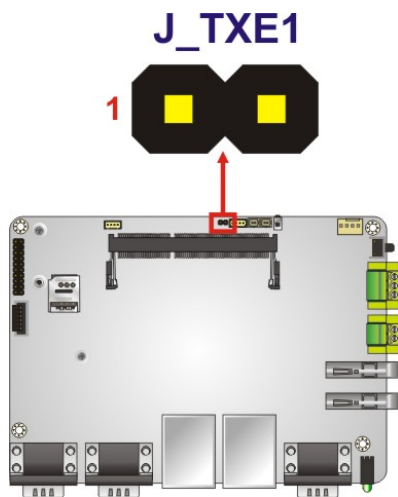

**Figure 4-2: TXE Override Jumper Location**

To update the TXE firmware, please follow the steps below.

- Step 1:** Before turning on the system power, short the TXE Override jumper.
- Step 2:** Update the BIOS and TXE firmware, and then turn off the system power.
- Step 3:** Remove the metal clip on the TXE Override jumper or return to its default setting (open).
- Step 4:** Restart the system. The system will reboot to complete the TXE firmware update.

Chapter

5

# BIOS

---

## 5.1 Introduction

The BIOS is programmed onto the BIOS chip. The BIOS setup program allows changes to certain system settings. This chapter outlines the options that can be changed.



### NOTE:

Some of the BIOS options may vary throughout the life cycle of the product and are subject to change without prior notice.

---

### 5.1.1 Starting Setup

The UEFI BIOS is activated when the computer is turned on. The setup program can be activated in one of two ways.

1. Press the **DEL** or **F2** key as soon as the system is turned on or
2. Press the **DEL** or **F2** key when the “**Press DEL or F2 to enter SETUP**” message appears on the screen.

If the message disappears before the **DEL** or **F2** key is pressed, restart the computer and try again.

### 5.1.2 Using Setup

Use the arrow keys to highlight items, press **ENTER** to select, use the PageUp and PageDown keys to change entries, press **F1** for help and press **ESC** to quit. Navigation keys are shown in **Table 5-1**.

Key	Function
Up arrow	Move to previous item
Down arrow	Move to next item
Left arrow	Move to the item on the left hand side
Right arrow	Move to the item on the right hand side
+	Increase the numeric value or make changes



## DRPC-130-AL Embedded System

Key	Function
-	Decrease the numeric value or make changes
Esc key	Main Menu – Quit and not save changes into CMOS Status Page Setup Menu and Option Page Setup Menu -- Exit current page and return to Main Menu
F1 key	General help, only for Status Page Setup Menu and Option Page Setup Menu
F2 key	Load previous values
F3 key	Load optimized defaults
F4 key	Save changes and exit BIOS

**Table 5-1: BIOS Navigation Keys**

### 5.1.3 Getting Help

When **F1** is pressed a small help window describing the appropriate keys to use and the possible selections for the highlighted item appears. To exit the Help Window press **Esc** or the **F1** key again.

### 5.1.4 Unable to Reboot after Configuration Changes

If the computer cannot boot after changes to the system configuration is made, CMOS defaults. Use the clear CMOS button described in **Chapter 3**.

### 5.1.5 BIOS Menu Bar

The **menu bar** on top of the BIOS screen has the following main items:

- Main – Changes the basic system configuration.
- Advanced – Changes the advanced system settings.
- Chipset – Changes the chipset settings.
- Security – Sets User and Supervisor Passwords.
- Boot – Changes the system boot configuration.
- Save & Exit – Selects exit options and loads default settings

The following sections completely describe the configuration options found in the menu items at the top of the BIOS screen and listed above.

### 5.2 Main

The **Main** BIOS menu (**BIOS Menu 1**) appears when the **BIOS Setup** program is entered.

The **Main** menu gives an overview of the basic system information.

```

Aptio Setup Utility - Copyright (C) 2018 American Megatrends, Inc.
Main  Advanced  Chipset  Security  Boot  Save & Exit

BIOS Information
BIOS Vendor                American Megatrends
Core Version                5.12
Compliance                 UEFI 2.5;PI1.4
Project Version             Z436AR13.BIN
Build Date and Time        03/29/2018 10:46:26

iWDD Vendor                iEi
iWDD Version                B449ET12.bin

Platform firmware Information
BXT SOC                    D0
MRC Version                0.56
PUNIT FW                   2E
PMC FW                     03.29
TXE FW                     3.1.50.2238
ISH FW                     4.1.0.3364
GOP                        0.0.0036

Memory Information
Total Memory                4096 MB
Memory Speed                1600 MHz

Access Level                Administrator

System Date                 [Tue 01/01/2017]
System Time                 [01:10:27]

Set the Date. Use Tab to
switch between Data
elements.

-----
<->: Select Screen
^ v: Select Item
Enter>Select
+ -: Change Opt.
F1:  General Help
F2:  Previous Values
F3:  Optimized Defaults
F4:  Save & Exit
ESC: Exit

Version 2.18.1263. Copyright (C) 2018 American Megatrends, Inc.
  
```

#### BIOS Menu 1: Main

The System Overview field has two user configurable fields:

## DRPC-130-AL Embedded System

### → System Date [xx/xx/xx]

Use the **System Date** option to set the system date. Manually enter the day, month and year.

### → System Time [xx:xx:xx]

Use the **System Time** option to set the system time. Manually enter the hours, minutes and seconds.

## 5.3 Advanced

Use the **Advanced** menu (**BIOS Menu 2**) to configure the CPU and peripheral devices through the following sub-menus:



### **WARNING!**

Setting the wrong values in the sections below may cause the system to malfunction. Make sure that the settings made are compatible with the hardware.

```

Aptio Setup Utility - Copyright (C) 2018 American Megatrends, Inc.
Main  Advanced  Chipset  Security  Boot  Save & Exit
-----
> Trusted Computing
> ACPI Settings
> F81866 Super IO Configuration
> iWDD H/W Monitor
> USB Configuration
> CPU Configuration
> RTC Wake Settings
> Power Saving Configuration
> Serial Port Console Redirection
> IEI Feature

System ACPI Parameters
-----
<=>: Select Screen
↑ ↓: Select Item
Enter>Select
+ - Change Opt.
F1 General Help
F2 Previous Values
F3 Optimized Defaults
F4 Save & Exit
ESC Exit

Version 2.18.1263. Copyright (C) 2018 American Megatrends, Inc.
    
```

### **BIOS Menu 2: Advanced**

### 5.3.1 Trusted Computing

Use the **Trusted Computing** menu (**BIOS Menu 3**) to configure settings related to the Trusted Computing Group (TCG) Trusted Platform Module (TPM).

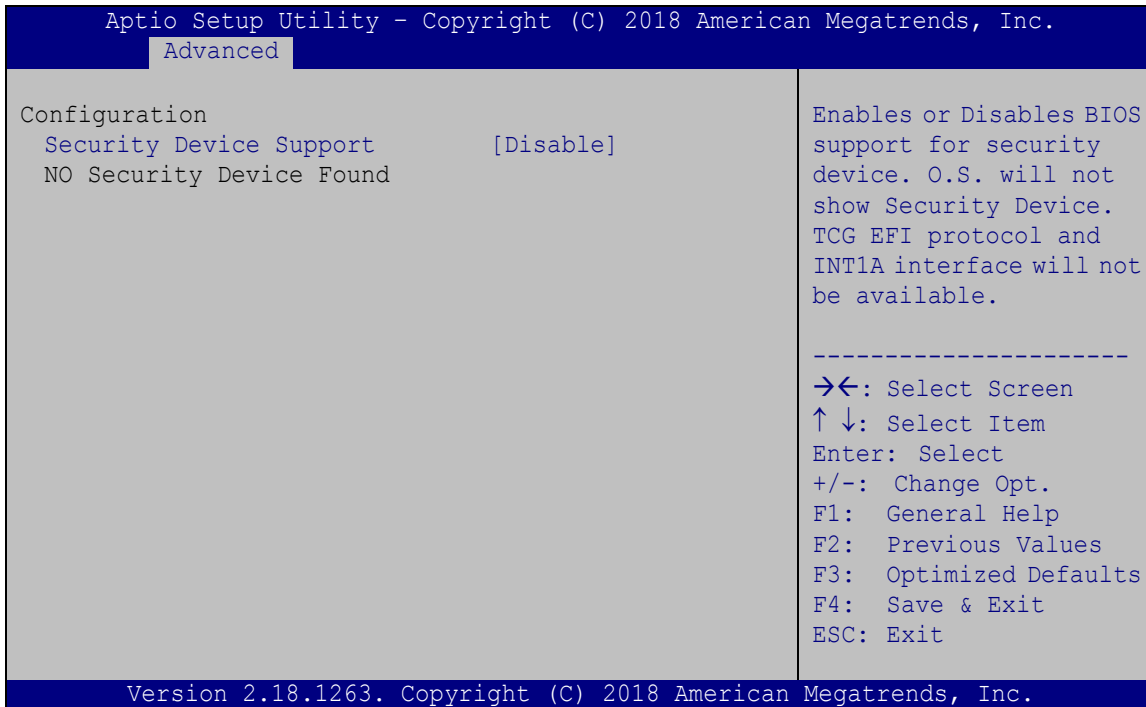

#### BIOS Menu 3: Trusted Computing

##### → Security Device Support [Disable]

Use the **Security Device Support** option to configure support for the TPM.

- **Disable**    **DEFAULT**    TPM support is disabled.
- **Enable**                    TPM support is enabled.

## DRPC-130-AL Embedded System

### 5.3.2 ACPI Settings

The **ACPI Settings** menu (**BIOS Menu 4**) configures the Advanced Configuration and Power Interface (ACPI) options.

```

Aptio Setup Utility - Copyright (C) 2018 American Megatrends, Inc.
Advanced
ACPI Settings
ACPI Sleep State [S3 (Suspend to RAM)]
Select the highest ACPI sleep state the system will enter when the SUSPEND button is pressed.
-----
<=>: Select Screen
↑ ↓: Select Item
Enter>Select
+ - Change Opt.
F1 General Help
F2 Previous Values
F3 Optimized Defaults
F4 Save & Exit
ESC Exit
Version 2.18.1263. Copyright (C) 2018 American Megatrends, Inc.

```

#### BIOS Menu 4: ACPI Configuration

##### → **ACPI Sleep State [S3 (Suspend to RAM)]**

Use the **ACPI Sleep State** option to specify the sleep state the system enters when it is not being used.

- **S3 (Suspend to DEFAULT RAM)** The caches are flushed and the CPU is powered off. Power to the RAM is maintained. The computer returns slower to a working state, but more power is saved.



### 5.3.3 F81866 Super IO Configuration

Use the **F81866 Super IO Configuration** menu (**BIOS Menu 5**) to set or change the configurations for the serial ports.

```

Aptio Setup Utility - Copyright (C) 2018 American Megatrends, Inc.
  Advanced
F81866 Super IO Configuration                               Set Parameters of Serial
                                                           Port 1 (COMA)
F81866 Super IO Chip                                     F81866
> Serial Port 1 Configuration
> Serial Port 2 Configuration
> Serial Port 3 Configuration
> Serial Port 4 Configuration
                                                           -----
                                                           ←→: Select Screen
                                                           ↑ ↓: Select Item
                                                           EnterSelect
                                                           + - Change Opt.
                                                           F1  General Help
                                                           F2  Previous Values
                                                           F3  Optimized Defaults
                                                           F4  Save & Exit
                                                           ESC  Exit
Version 2.18.1263. Copyright (C) 2018 American Megatrends, Inc.
    
```

**BIOS Menu 5: F81866 Super IO Configuration**

#### 5.3.3.1 Serial Port n Configuration

Use the **Serial Port n Configuration** menu (**BIOS Menu 6**) to configure the serial port n.

```

Aptio Setup Utility - Copyright (C) 2018 American Megatrends, Inc.
  Advanced
Serial Port n Configuration                               Enable or Disable Serial
                                                           Port (COM)
Serial Port                                             [Enabled]
Device Settings                                       IO=3F8h;IRQ=4
                                                           -----
Change Settings                                       [IO=3F8h; IRQ=4;]
Transfer Mode                                         [RS232]
                                                           ←→: Select Screen
                                                           ↑ ↓: Select Item
                                                           EnterSelect
                                                           = - Change Opt.
                                                           F1  General Help
                                                           F2  Previous Values
                                                           F3  Optimized Defaults
                                                           F4  Save & Exit
                                                           ESC  Exit
Version 2.18.1263. Copyright (C) 2018 American Megatrends, Inc.
    
```

**BIOS Menu 6: Serial Port n Configuration Menu**

## DRPC-130-AL Embedded System

### 5.3.3.1.1 Serial Port 1 Configuration

#### → Serial Port [Enabled]

Use the **Serial Port** option to enable or disable the serial port.

- **Disabled**                      Disable the serial port
- **Enabled      DEFAULT**      Enable the serial port

#### → Change Settings [IO=3F8h; IRQ=4]

Use the **Change Settings** option to change the serial port IO port address and interrupt address.

- **IO=3F8h;      DEFAULT**      Serial Port I/O port address is 3F8h and the interrupt address is IRQ4
- **IO=3F8h;      IRQ=3,4,10**                      Serial Port I/O port address is 3F8h and the interrupt address is IRQ3, 4, 10
- **IO=2F8h;      IRQ=3,4,10**                      Serial Port I/O port address is 2F8h and the interrupt address is IRQ3, 4, 10
- **IO=3E8h;      IRQ=3,4,10**                      Serial Port I/O port address is 3E8h and the interrupt address is IRQ3, 4, 10
- **IO=2E8h;      IRQ=3,4,10**                      Serial Port I/O port address is 2E8h and the interrupt address is IRQ3, 4, 10

#### → Transfer Mode [RS232]

Use the **Transfer Mode** option to select the Serial Port 5 signaling mode.

- **RS422**                              Serial Port 5 signaling mode is RS-422
- **RS232      DEFAULT**              Serial Port 5 signaling mode is RS-232
- **RS485**                              Serial Port 5 signaling mode is RS-485

### 5.3.3.1.2 Serial Port 2 Configuration

→ **Serial Port [Enabled]**

Use the **Serial Port** option to enable or disable the serial port.

- **Disabled**                      Disable the serial port
- **Enabled      DEFAULT**      Enable the serial port

→ **Change Settings [IO=2F8h; IRQ=3]**

Use the **Change Settings** option to change the serial port IO port address and interrupt address.

- **IO=2F8h;      DEFAULT      IRQ=3**      Serial Port I/O port address is 2F8h and the interrupt address is IRQ3
- **IO=3F8h;      IRQ=3,4,10**      Serial Port I/O port address is 3F8h and the interrupt address is IRQ3, 4, 10
- **IO=2F8h;      IRQ=3,4,10**      Serial Port I/O port address is 2F8h and the interrupt address is IRQ3, 4, 10
- **IO=3E8h;      IRQ=3,4,10**      Serial Port I/O port address is 3E8h and the interrupt address is IRQ3, 4, 10
- **IO=2E8h;      IRQ=3,4,10**      Serial Port I/O port address is 2E8h and the interrupt address is IRQ3, 4, 10

→ **Transfer Mode [RS232]**

Use the **Transfer Mode** option to select the Serial Port 5 signaling mode.

- **RS422**                      Serial Port 5 signaling mode is RS-422
- **RS232      DEFAULT**      Serial Port 5 signaling mode is RS-232
- **RS485**                      Serial Port 5 signaling mode is RS-485

## DRPC-130-AL Embedded System

### 5.3.3.1.3 Serial Port 3 Configuration

#### → Serial Port [Enabled]

Use the **Serial Port** option to enable or disable the serial port.

- **Disabled**                      Disable the serial port
- **Enabled      DEFAULT**      Enable the serial port

#### → Change Settings [IO=3F8h; IRQ=10]

Use the **Change Settings** option to change the serial port IO port address and interrupt address.

- **IO=3F8h;      DEFAULT**      Serial Port I/O port address is 3F8h and the interrupt address is IRQ10
- **IO=3E8h;      IRQ=3,4,10**                      Serial Port I/O port address is 3E8h and the interrupt address is IRQ3, 4, 10
- **IO=2E8h;      IRQ=3,4,10**                      Serial Port I/O port address is 2E8h and the interrupt address is IRQ3, 4, 10
- **IO=3E0h;      IRQ=3,4,10**                      Serial Port I/O port address is 3E0h and the interrupt address is IRQ3, 4, 10
- **IO=2E0h;      IRQ=3,4,10**                      Serial Port I/O port address is 2E0h and the interrupt address is IRQ3, 4, 10

#### → Transfer Mode [RS232]

Use the **Transfer Mode** option to select the Serial Port 5 signaling mode.

- **RS422**                              Serial Port 5 signaling mode is RS-422
- **RS232      DEFAULT**              Serial Port 5 signaling mode is RS-232
- **RS485**                              Serial Port 5 signaling mode is RS-485

**5.3.3.1.4 Serial Port 4 Configuration**

➔ **Serial Port [Enabled]**

Use the **Serial Port** option to enable or disable the serial port.

- ➔ **Disabled**                      Disable the serial port
- ➔ **Enabled      DEFAULT**      Enable the serial port

➔ **Change Settings [IO=2E8h; IRQ=10]**

Use the **Change Settings** option to change the serial port IO port address and interrupt address.

- ➔ **IO=2E8h;      DEFAULT      IRQ=10**      Serial Port I/O port address is 2E8h and the interrupt address is IRQ10
- ➔ **IO=3E8h;      IRQ=3,4,10**      Serial Port I/O port address is 3E8h and the interrupt address is IRQ3, 4, 10
- ➔ **IO=2E8h;      IRQ=3,4,10**      Serial Port I/O port address is 2E8h and the interrupt address is IRQ3, 4, 10
- ➔ **IO=3E0h;      IRQ=3,4,10**      Serial Port I/O port address is 3E0h and the interrupt address is IRQ3, 4, 10
- ➔ **IO=2E0h;      IRQ=3,4,10**      Serial Port I/O port address is 2E0h and the interrupt address is IRQ3, 4, 10

➔ **Transfer Mode [RS232]**

Use the **Transfer Mode** option to select the Serial Port 5 signaling mode.

- ➔ **RS422**                      Serial Port 5 signaling mode is RS-422
- ➔ **RS232      DEFAULT**      Serial Port 5 signaling mode is RS-232
- ➔ **RS485**                      Serial Port 5 signaling mode is RS-485



## DRPC-130-AL Embedded System

### 5.3.4 iWDD H/W Monitor

The **iWDD H/W Monitor** menu (**BIOS Menu 7**) contains the fan configuration submenus and displays operating temperature and system voltages.

```

Aptio Setup Utility - Copyright (C) 2018 American Megatrends, Inc.
-----
Advanced
-----
PC Health Status
System temperature           :+30 °C

CPU_CORE                    :+0.829 V
+5V                          :+5.023 V
+DDR                        :+1.348 V
+5VSB                       :+5.023 V
+3.3V                       :+3.265 V
+3.3VSB                     :+3.306 V

Smart Fan Mode Select

-----
<->: Select Screen
↑↓: Select Item
EnterSelect
+ - Change Opt.
F1  General Help
F2  Previous Values
F3  Optimized Defaults
F4  Save & Exit
ESC Exit

Version 2.18.1263. Copyright (C) 2018 American Megatrends, Inc.

```

#### BIOS Menu 7: iWDD H/W Monitor

##### → PC Health Status

The following system parameters and values are shown. The system parameters that are monitored are:

- System Temperatures
- Voltages:
  - CPU\_CORE
  - +5V
  - +DDR
  - +5VSB
  - +3.3V
  - +3.3VSB

### 5.3.5 USB Configuration

Use the **USB Configuration** menu (**BIOS Menu 8**) to read USB configuration information and configure the USB settings.

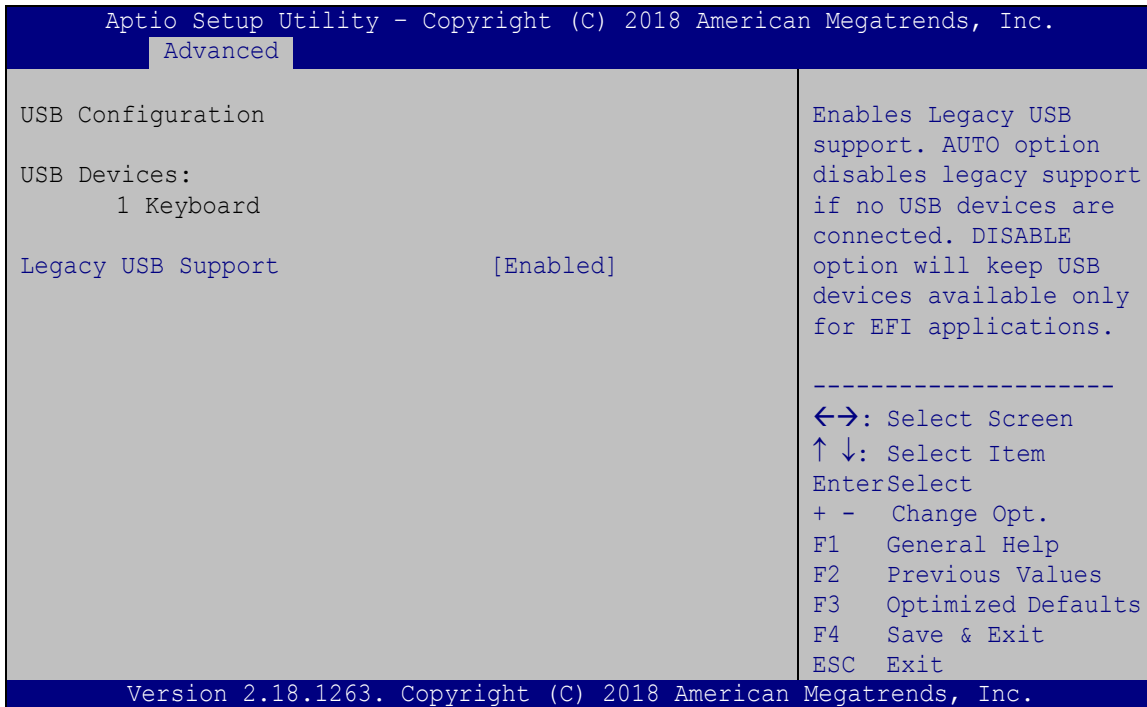

#### BIOS Menu 8: USB Configuration

##### ➔ USB Devices

The **USB Devices Enabled** field lists the USB devices that are enabled on the system

##### ➔ Legacy USB Support [Enabled]

Use the **Legacy USB Support** BIOS option to enable USB mouse and USB keyboard support. Normally if this option is not enabled, any attached USB mouse or USB keyboard does not become available until a USB compatible operating system is fully booted with all USB drivers loaded. When this option is enabled, any attached USB mouse or USB keyboard can control the system even when there is no USB driver loaded onto the system.

➔ **Enabled**      **DEFAULT**      Legacy USB support enabled

## DRPC-130-AL Embedded System

- ➔ **Disabled** Legacy USB support disabled
- ➔ **Auto** Legacy USB support disabled if no USB devices are connected

### 5.3.6 CPU Configuration

Use the **CPU Configuration** BIOS menu (**BIOS Menu 9**) to view detailed CPU specifications and configure the CPU.

```

Aptio Setup Utility - Copyright (C) 2018 American Megatrends, Inc.
  Advanced
CPU Configuration
Intel(R) Atom(TM) Processor E3930 @ 1.30GHz
CPU Signature          506C9
Microcode Patch       2E
Max CPU Speed         1300 MHz
Min CPU Speed         800 MHz
Processor Cores       2
Intel HT Technology   Not Supported
Intel VT-x Technology Supported
-----
L1 Data Cache        24 kB x 4
L1 Code Cache        32 kB x 4
L2 Cache             1024 kB x 2
L3 Cache             Not Present

EIST                  [Enabled]
C-States              [Disabled]
Intel Virtualization Technology [Disabled]
VT-d                  [Disabled]

Enable/Disable Intel SpeedStep

<->: Select Screen
↑ ↓: Select Item
Enter>Select
+ - Change Opt.
F1  General Help
F2  Previous Values
F3  Optimized Defaults
F4  Save & Exit
ESC Exit

Version 2.18.1263. Copyright (C) 2018 American Megatrends, Inc.
  
```

#### BIOS Menu 9: CPU Configuration

The CPU Configuration menu (**BIOS Menu 9**) lists the following CPU details:

- CPU Signature: Lists the CPU signature value.
- Microcode Patch: Lists the microcode patch being used.
- Max CPU Speed: Lists the maximum CPU processing speed.
- Min CPU Speed: Lists the minimum CPU processing speed.
- Processor Cores: Lists the number of the processor core
- Intel HT Technology: Indicates if Intel HT Technology is supported by the CPU.

- Intel VT-x Technology: Indicates if Intel VT-x Technology is supported by the CPU.
- L1 Data Cache: Lists the amount of data storage space on the L1 cache.
- L1 Code Cache: Lists the amount of code storage space on the L1 cache.
- L2 Cache: Lists the amount of storage space on the L2 cache.
- L3 Cache: Lists the amount of storage space on the L3 cache.

### → EIST [Enabled]

Use the **EIST** option to enable or disable Enhanced Intel SpeedStep® Technology (EIST).

- **Disabled** Disables Enhanced Intel SpeedStep® Technology.
- **Enabled** **DEFAULT** Enables Enhanced Intel SpeedStep® Technology.

### → C states [Disabled]

Use the **C states** option to enable or disable CPU power management which allows CPU to go to C states when it is not 100% utilized.

- **Disabled** **DEFAULT** Disables CPU power management
- **Enabled** Enables CPU power management

### → Intel Virtualization Technology [Disabled]

Use the **Intel Virtualization Technology** option to enable or disable virtualization on the system. When combined with third party software, Intel® Virtualization technology allows several OSs to run on the same system at the same time.

- **Disabled** **DEFAULT** Disables Intel Virtualization Technology.
- **Enabled** Enables Intel Virtualization Technology.

## DRPC-130-AL Embedded System

### → VT-d [Disabled]

Use the **VT-d** option to enable or disable VT-d capability.

- **Disabled**                      **DEFAULT**      Disables VT-d capability.
- **Enabled**    Enables VT-d capability.

### 5.3.7 RTC Wake Settings

The **RTC Wake Settings** menu (**BIOS Menu 10**) configures RTC wake event.

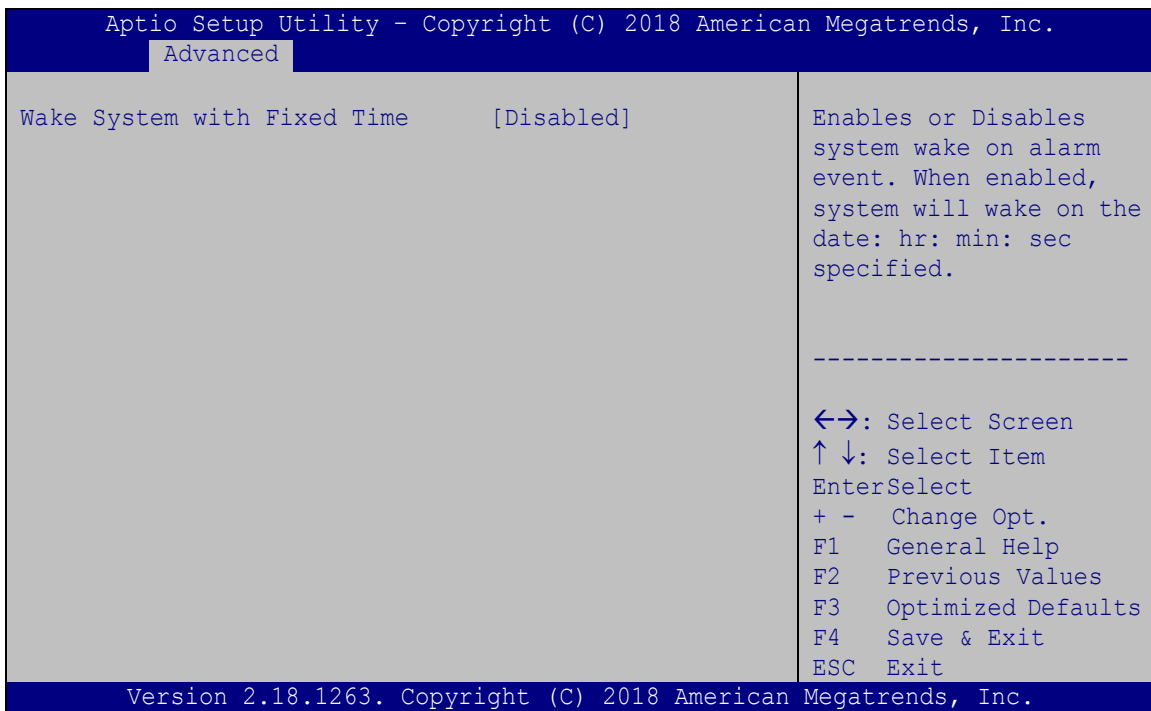

#### BIOS Menu 10: RTC Wake Settings

### → Wake System with Fixed Time [Disabled]

Use the **Wake System with Fixed Time** option to specify the time the system should be roused from a suspended state.

- **Disabled**      **DEFAULT**      The real time clock (RTC) cannot generate a wake event



➔ **Enabled**

If selected, the following appears with values that can be selected:

- \*Wake up every day
- \*Wake up date
- \*Wake up hour
- \*Wake up minute
- \*Wake up second

After setting the alarm, the computer turns itself on from a suspend state when the alarm goes off.

### 5.3.8 Power Saving Configuration

Use the **Power Saving Configuration** menu (**BIOS Menu 11**) to configure system to reduce power consumption in system off state.

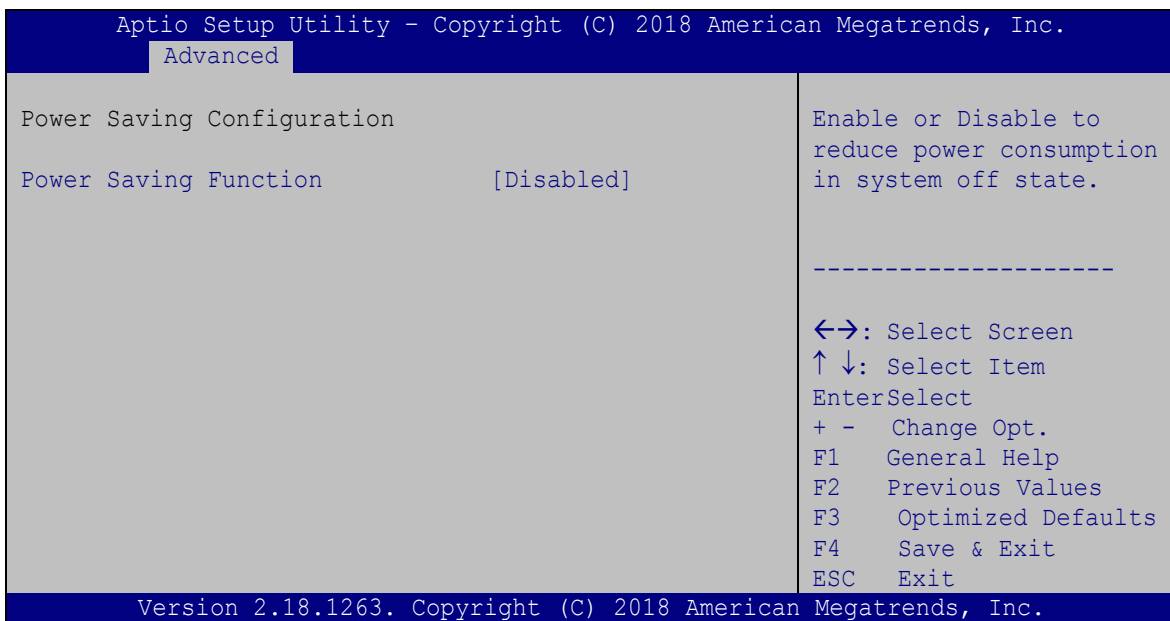

#### BIOS Menu 11: Power Saving Configuration

➔ **Power Saving Function(ERP) [Disabled]**

Use the **Power Saving Function** BIOS option to enable or disable the power saving function.



The following options are available in the **Console Redirection Settings** submenu when the Console Redirection option is enabled.

→ **Terminal Type [ANSI]**

Use the **Terminal Type** option to specify the remote terminal type.

- **VT100**                      The target terminal type is VT100
- **VT100+**                    The target terminal type is VT100+
- **VT-UTF8**                    The target terminal type is VT-UTF8
- **ANSI**                      **DEFAULT**                    The target terminal type is ANSI

→ **Bits per second [115200]**

Use the **Bits per second** option to specify the serial port transmission speed. The speed must match the other side. Long or noisy lines may require lower speeds.

- **9600**                        Sets the serial port transmission speed at 9600.
- **19200**                      Sets the serial port transmission speed at 19200.
- **57600**                      Sets the serial port transmission speed at 57600.
- **115200**                    **DEFAULT**                    Sets the serial port transmission speed at 115200.

→ **Data Bits [8]**

Use the **Data Bits** option to specify the number of data bits.

- **7**                              Sets the data bits at 7.
- **8**                              **DEFAULT**                    Sets the data bits at 8.

→ **Parity [None]**

Use the **Parity** option to specify the parity bit that can be sent with the data bits for detecting the transmission errors.

- **None**                      **DEFAULT**                    No parity bit is sent with the data bits.

## DRPC-130-AL Embedded System

- ➔ **Even**                      The parity bit is 0 if the number of ones in the data bits is even.
- ➔ **Odd**                        The parity bit is 0 if the number of ones in the data bits is odd.
- ➔ **Mark**                      The parity bit is always 1. This option does not provide error detection.
- ➔ **Space**                     The parity bit is always 0. This option does not provide error detection.

### ➔ **Stop Bits [1]**

Use the **Stop Bits** option to specify the number of stop bits used to indicate the end of a serial data packet. Communication with slow devices may require more than 1 stop bit.

- ➔ **1**                      **DEFAULT**                Sets the number of stop bits at 1.
- ➔ **2**                      Sets the number of stop bits at 2.

### 5.3.9.1 Legacy Console Redirection Settings

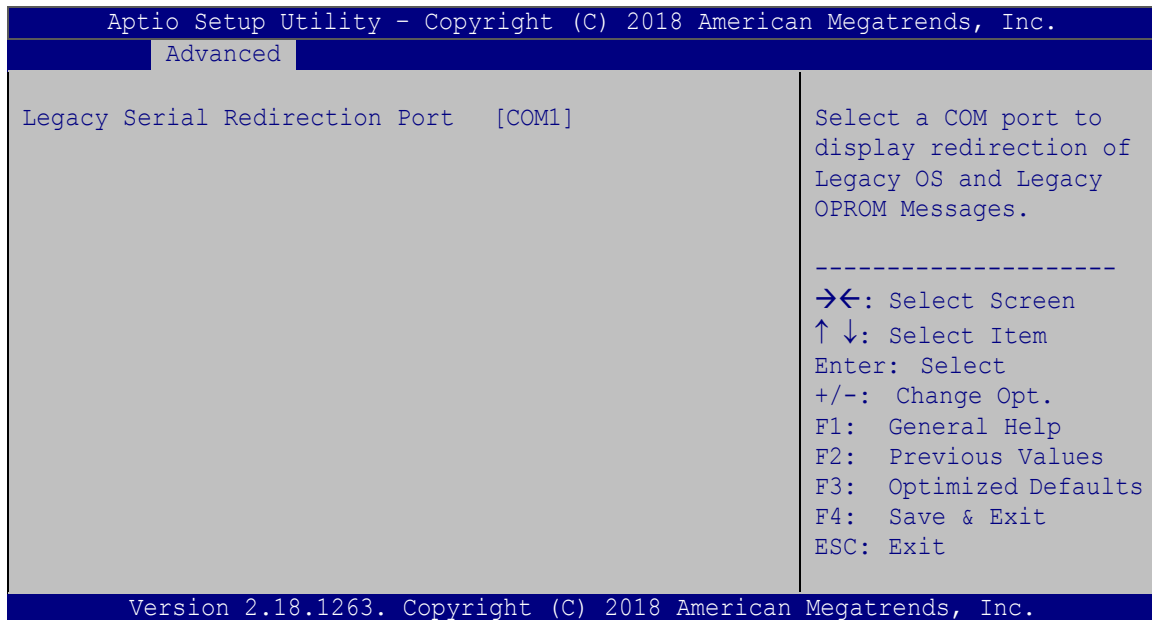

**BIOS Menu 13: Legacy Console Redirection Settings**

### → Legacy Serial Redirection Port [COM1]

Use the **Legacy Serial Redirection Port** option to select a COM port to display redirection of legacy OS and legacy OPRM messages. Configuration options are listed below.

- COM1 **Default**
- COM2
- COM3
- COM4

### 5.3.10 IEI Feature

Use the **iEi Feature** menu (**BIOS Menu 14**) to configure One Key Recovery function.

```

Aptio Setup Utility - Copyright (C) 2018 American Megatrends, Inc.
  Advanced
-----
iEi Feature
Auto Recovery Function          [Disabled]
                                Auto Recovery Function
                                Reboot and recover
                                system automatically
                                within 10 min, when OS
                                crashes. Please install
                                Auto Recovery API
                                service before enabling
                                this function.
                                -----
                                →←: Select Screen
                                ↑↓: Select Item
                                Enter: Select
                                +/-: Change Opt.
                                F1: General Help
                                F2: Previous Values
                                F3: Optimized Defaults
                                F4: Save & Exit
                                ESC: Exit
Version 2.18.1263. Copyright (C) 2018 American Megatrends, Inc.

```

#### BIOS Menu 14: iEi Feature

### → Auto Recovery Function [Disabled]

Use the **Auto Recovery Function** BIOS option to enable or disable the auto recovery function of the IEI One Key Recovery.



## DRPC-130-AL Embedded System

- ➔ **Disabled**     **DEFAULT**     Auto recovery function disabled
- ➔ **Enabled**                     Auto recovery function enabled

### 5.4 Chipset

Use the **Chipset** menu (**BIOS Menu 15**) to access the North Bridge and South Bridge subsystem configuration menus.



#### **WARNING!**

Setting the wrong values for the Chipset BIOS selections in the Chipset BIOS menu may cause the system to malfunction.

```

Aptio Setup Utility - Copyright (C) 2018 American Megatrends, Inc.
Main   Advanced  Chipset  Security  Boot   Save & Exit

> North Bridge
> South Bridge

North Bridge Parameters.

-----
<=>: Select Screen
↑↓: Select Item
Enter>Select
+ - Change Opt.
F1  General Help
F2  Previous Values
F3  Optimized Defaults
F4  Save & Exit
ESC Exit

Version 2.18.1263. Copyright (C) 2018 American Megatrends, Inc.
    
```

**BIOS Menu 15: Chipset**

### 5.4.1 North Bridge

Use the **North Bridge** menu (**BIOS Menu 16**) to configure the north bridge parameters.

```
Aptio Setup Utility - Copyright (C) 2018 American Megatrends, Inc.
Chipset
> Intel IGD Configuration
> LCD Control

Memory Information
Total Memory          4096 MB (LPDDR3)
DIMM1                 4096 MB (LPDDR3)

-----
<->: Select Screen
↑ ↓: Select Item
EnterSelect
+ - Change Opt.
F1  General Help
F2  Previous Values
F3  Optimized Defaults
F4  Save & Exit
ESC Exit

Version 2.18.1263. Copyright (C) 2018 American Megatrends, Inc.
```

**BIOS Menu 16: North Bridge**

## DRPC-130-AL Embedded System

### 5.4.1.1 Intel IGD Configuration

Use the **Intel IGD Configuration** submenu (**BIOS Menu 17**) to configure the graphics settings.

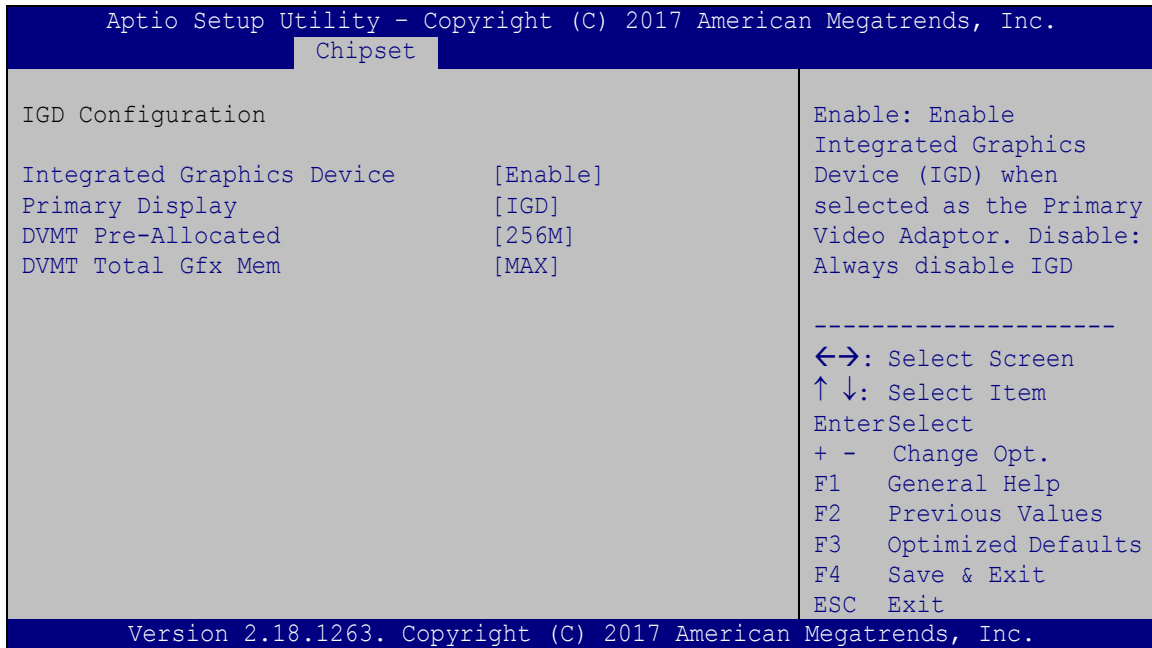

#### BIOS Menu 17: Intel IGD Configuration

##### → Integrated Graphics Device [Enable]

Use the **Integrated Graphics Device** BIOS option to enable or disable the Integrated Graphics Device (IGD).

→ **Disable**                      Disable IGD

→ **Enable**                      **DEFAULT**      Enable IGD

##### → Primary Display [IGD]

Use the **Primary Display** option to select the graphics controller used as the primary boot device. Select either an integrated graphics controller (IGD) or a PCI express (PEG) controller. Configuration options are listed below:

- IGD                      **DEFAULT**
- PCIe

**→ DVMT Pre-Allocated [256M]**

Use the **DVMT Pre-Allocated** option to specify the amount of system memory that can be used by the internal graphics device.

<b>→ 64M</b>		64 MB of memory used by internal graphics device
<b>→ 128M</b>		128 MB of memory used by internal graphics device
<b>→ 256M</b>	<b>DEFAULT</b>	256 MB of memory used by internal graphics device
<b>→ 512M</b>		512 MB of memory used by internal graphics device

**→ DVMT Total Gfx Mem [MAX]**

Use the **DVMT Total Gfx Mem** option to specify the maximum amount of memory that can be allocated as graphics memory. Configuration options are listed below.

- 128MB
- 256MB
- MAX **Default**

## DRPC-130-AL Embedded System

### 5.4.1.2 LCD Control

Use the **LCD Control** submenu (**BIOS Menu 18**) to select a display device which will be activated during POST.

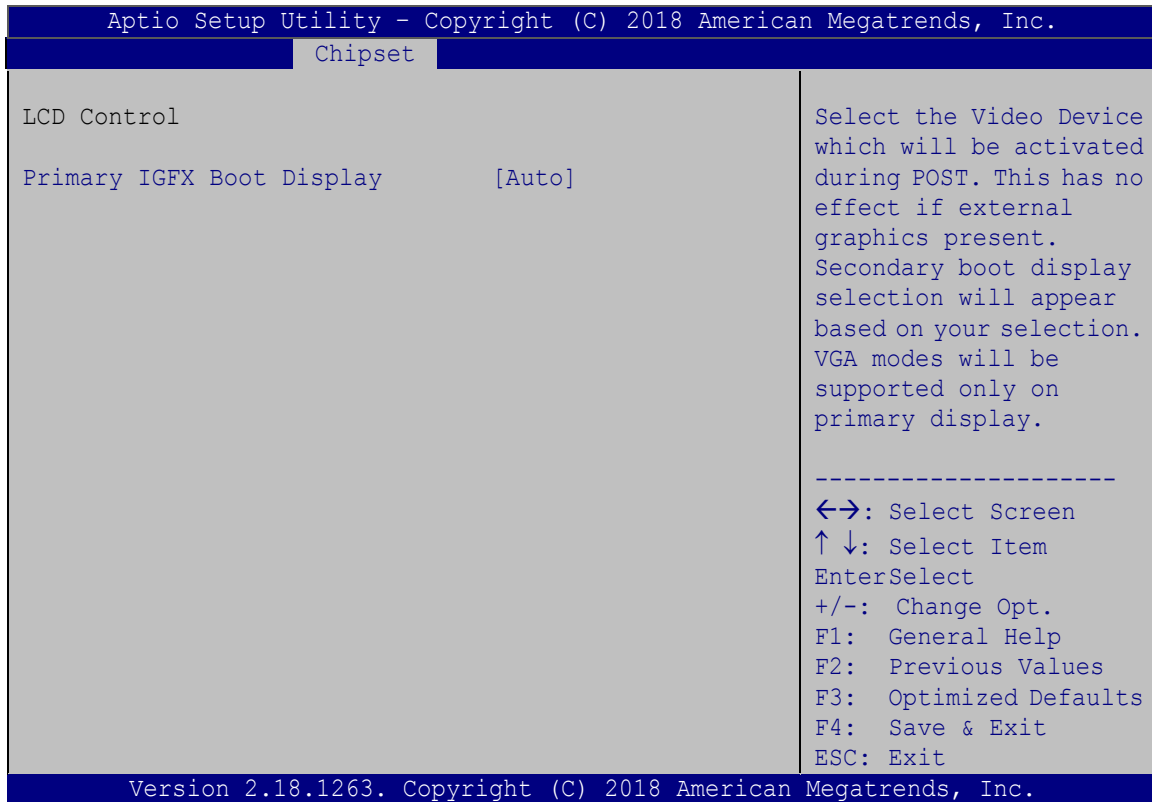

#### BIOS Menu 18: LCD Control

##### → Primary IGFX Boot Display [Auto]

Use the **Primary IGFX Boot Display** option to select the display device used by the system when it boots.

- Auto **DEFAULT**
- HDMI1
- HDMI2



### 5.4.2 South Bridge

Use the **South Bridge** menu (**BIOS Menu 19**) to configure the south bridge parameters.

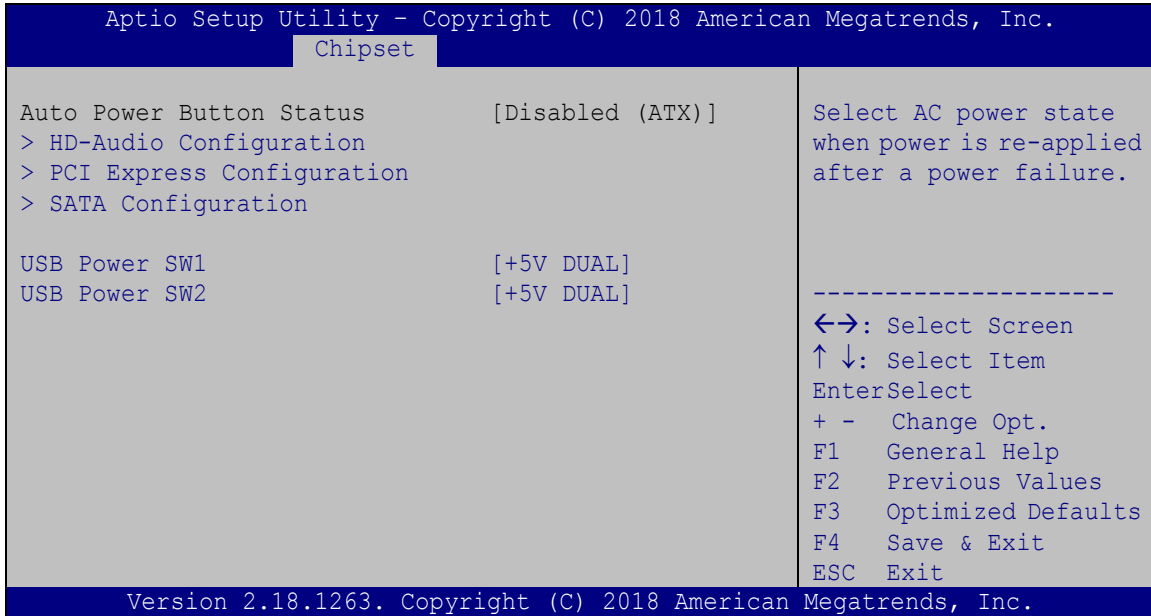

#### BIOS Menu 19: South Bridge

##### → USB Power SW1 [+5V DUAL]

Use the **USB Power SW1** BIOS option to configure the USB power source for the corresponding USB connectors (**Table 5-2**).

- **+5V DUAL**    **DEFAULT**    Sets the USB power source to +5V dual
- **+5V**                                Sets the USB power source to +5V

##### → USB Power SW2 [+5V DUAL]

Use the **USB Power SW2** BIOS option to configure the USB power source for the corresponding USB connectors (**Table 5-2**).

- **+5V DUAL**    **DEFAULT**    Sets the USB power source to +5V dual
- **+5V**                                Sets the USB power source to +5V

## DRPC-130-AL Embedded System

BIOS Options	Configured USB Ports
USB Power SW1	LAN1_USB1 (external USB 3.2 Gen 1 ports)
	LAN2_USB1 (external USB 3.2 Gen 1 ports)
USB Power SW2	USB2-2 (internal USB 2.0 port)

**Table 5-2: BIOS Options and Configured USB Ports**

### 5.4.2.1 HD-Audio Configuration

Use the **HD-Audio Configuration** menu (**BIOS Menu 20**) to configure the HD Audio.

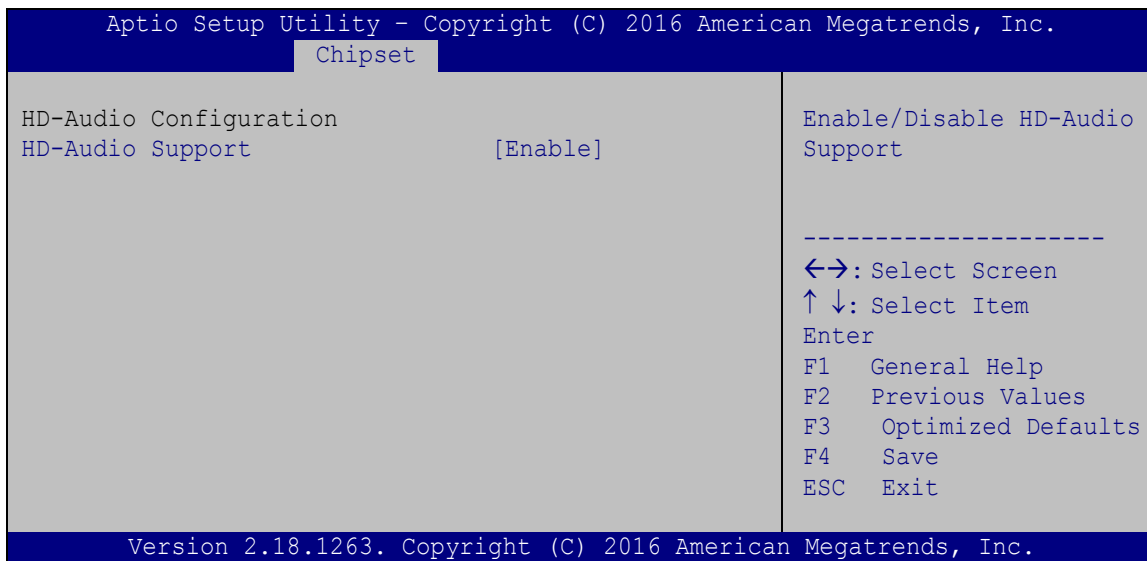

**BIOS Menu 20: HD-Audio Configuration**

#### → HD-Audio Support [Enable]

Use the **HD-Audio Support** option to enable or disable the High Definition Audio controller.

- **Disable**                      The onboard High Definition Audio controller is disabled
- **Enable**      **DEFAULT**      The onboard High Definition Audio controller is detected automatically and enabled

### 5.4.2.2 PCI Express Configuration

Use the **PCI Express Configuration** submenu (**BIOS Menu 21**) to configure the PCI Express slots.

```

Aptio Setup Utility - Copyright (C) 2018 American Megatrends, Inc.
Chipset
-----
PCI Express Configuration
> Onboard LAN1
> Onboard LAN2
> MPCIE1
> MPCIE2

Control the PCI Express Root Port.
AUTO: To disable unused root port automatically for the most optimum power savings.
Enable: Enable PCIe root port
Disable: Disable PCIe root port

-----
<=>: Select Screen
↑ ↓: Select Item
Enter>Select
+ - Change Opt.
F1 General Help
F2 Previous Values
F3 Optimized Defaults
F4 Save & Exit
ESC Exit

Version 2.18.1263. Copyright (C) 2018 American Megatrends, Inc.
  
```

**BIOS Menu 21: PCI Express Configuration**

## DRPC-130-AL Embedded System

### 5.4.2.2.1 Onboard LAN1/LAN2

Use the **Onboard LAN1/LAN2** menu (**BIOS Menu 22**) to configure the LAN 1 or LAN 2 port.

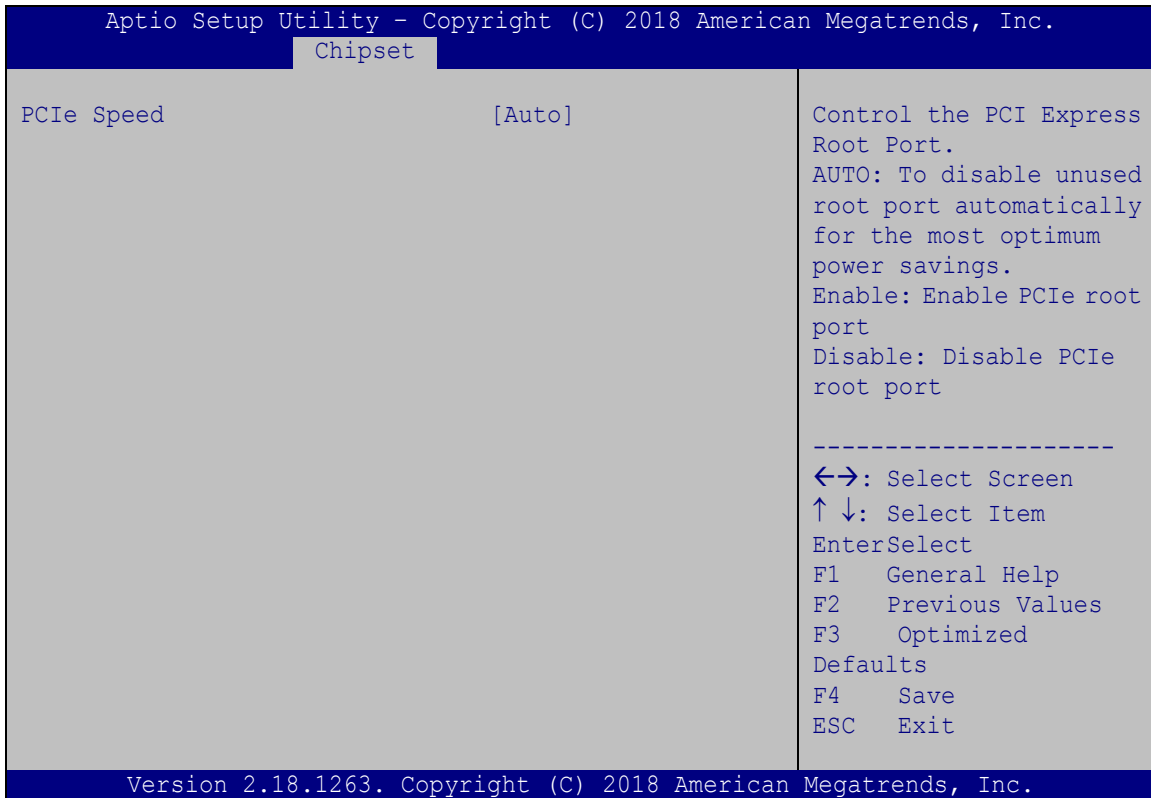

#### BIOS Menu 22: Onboard LAN1/LAN2

##### → PCIe Speed [Auto]

Use the **PCIe Speed** option to configure PCIe LAN speed.

- **Auto**      **DEFAULT**      Configure PCIe LAN speed to auto
- **Gen1**                     Configure PCIe LAN speed to Gen1
- **Gen2**                     Configure PCIe LAN speed to Gen2

**5.4.2.2.2 MPCIE1/MPCIE2**

Use the **MPCIE1/MPCIE2** menu (**BIOS Menu 23**) to configure the PCIe Mini slots.

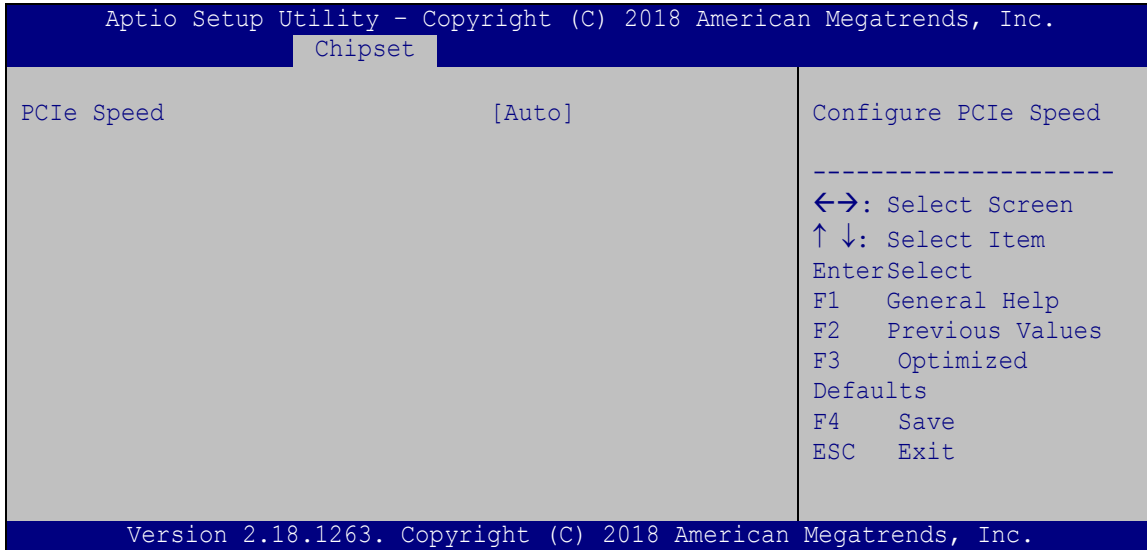

**BIOS Menu 23: MPCIE1/MPCIE2**

→ **PCIe Speed [Auto]**

Use the **PCIe Speed** option to configure PCIe Mini slot speed.

- **Auto**      **DEFAULT**      Configure PCIe Mini slot speed to auto
- **Gen1**                      Configure PCIe Mini slot speed to Gen1
- **Gen2**                      Configure PCIe Mini slot speed to Gen2



## DRPC-130-AL Embedded System

### 5.4.2.3 SATA Configuration

Use the **SATA Configuration** menu (**BIOS Menu 24**) to change and/or set the configuration of the SATA devices installed in the system.

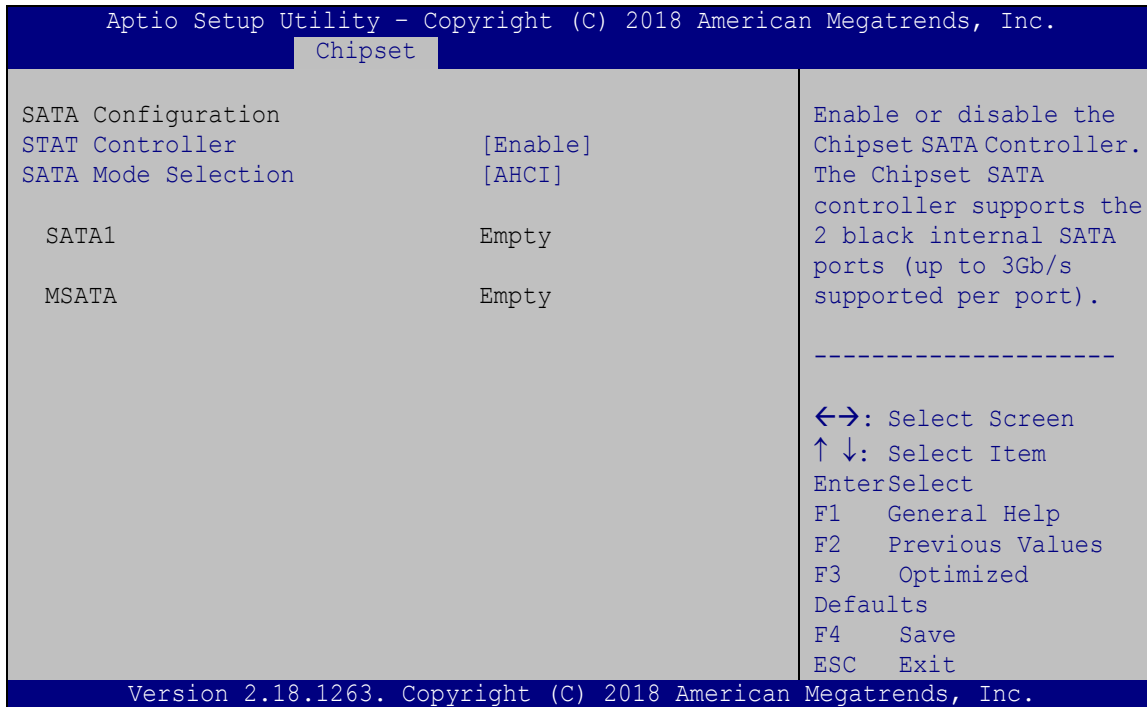

#### BIOS Menu 24: SATA Configuration

##### → **STAT Controller [Enable]**

Use the **STAT Controller** option to enable or disable the SATA device.

- **Enable**      **DEFAULT**      Enables the SATA device.
- **Disable**      Disables the SATA device.

##### → **SATA Mode Selection [AHCI]**

Use the **SATA Mode Selection** option to configure SATA devices as AHCI devices.

- **AHCI**      **DEFAULT**      Configures SATA devices as AHCI device.

## 5.5 Security

Use the **Security** menu (**BIOS Menu 25**) to set system and user passwords.

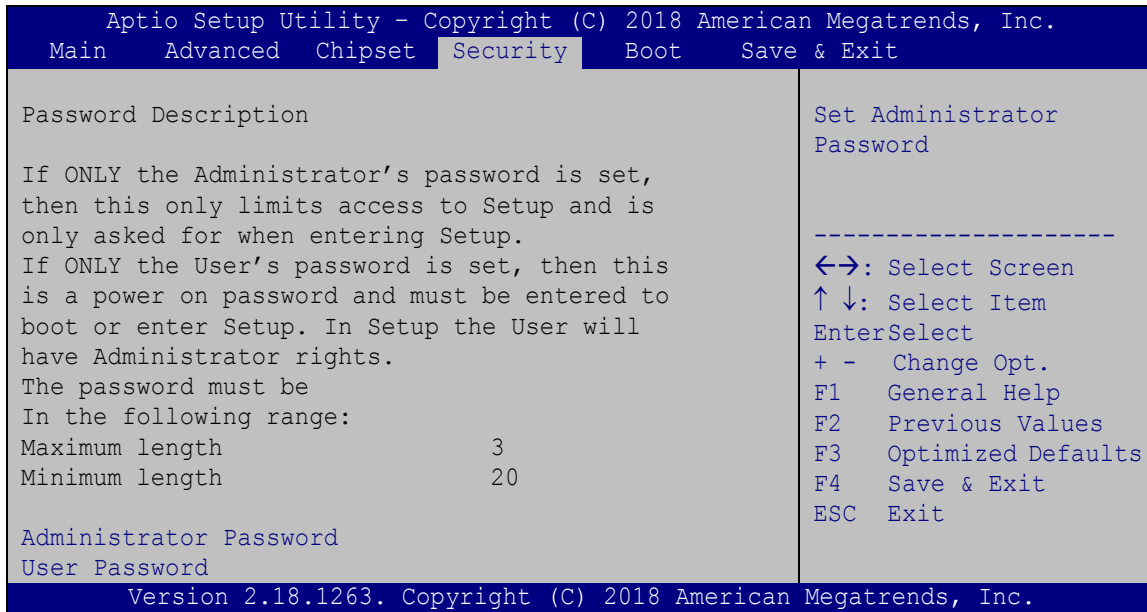

### BIOS Menu 25: Security

#### → Administrator Password

Use the **Administrator Password** to set or change an administrator password.

#### → User Password

Use the **User Password** to set or change a user password.

## DRPC-130-AL Embedded System

### 5.6 Boot

Use the **Boot** menu (**BIOS Menu 26**) to configure system boot options.

```

Aptio Setup Utility - Copyright (C) 2018 American Megatrends, Inc.
Main   Advanced  Chipset  Security  Boot   Save & Exit
-----
Boot Configuration
Bootup NumLock State      [On]
Quiet Boot                 [Enabled]
Launch PXE OpROM          [Disabled]
Option ROM Messages       [Force BIOS]
UEFI Boot                  [Disabled]

Driver Option Priorities
Boot Option Priorities

Select the keyboard
NumLock state

-----
<->: Select Screen
↑ ↓: Select Item
Enter>Select
+ -  Change Opt.
F1   General Help
F2   Previous Values
F3   Optimized Defaults
F4   Save & Exit
ESC  Exit

Version 2.18.1263. Copyright (C) 2018 American Megatrends, Inc.

```

#### BIOS Menu 26: Boot

##### → Bootup NumLock State [On]

Use the **Bootup NumLock State** BIOS option to specify if the number lock setting must be modified during boot up.

→ **On**                      **DEFAULT**                      Allows the Number Lock on the keyboard to be enabled automatically when the computer system boots up. This allows the immediate use of the 10-key numeric keypad located on the right side of the keyboard. To confirm this, the Number Lock LED light on the keyboard is lit.

→ **Off**                                      Does not enable the keyboard Number Lock automatically. To use the 10-keys on the keyboard, press the Number Lock key located on the upper left-hand corner of the 10-key pad. The Number Lock LED on the keyboard lights up when the Number Lock is engaged.

→ **Quiet Boot [Enabled]**

Use the **Quiet Boot** BIOS option to select the screen display when the system boots.

- **Disabled** Normal POST messages displayed
- **Enabled** **DEFAULT** OEM Logo displayed instead of POST messages

→ **Launch PXE OpROM [Disabled]**

Use the **Launch PXE OpROM** option to enable or disable boot option for legacy network devices.

- **Disabled** **DEFAULT** Ignore all PXE Option ROMs
- **Enabled** Load PXE Option ROMs

→ **Option ROM Messages [Force BIOS]**

Use the **Option ROM Messages** option to set the Option ROM display mode.

- **Force BIOS** **DEFAULT** Sets display mode to force BIOS.
- **Keep Current** Sets display mode to current.

→ **UEFI Boot [Disabled]**

Use the **UEFI Boot** option to enable or disable to boot from a UEFI device.

- **Enabled** Enable to boot from a UEFI device.
- **Disabled** **DEFAULT** Disable to boot from a UEFI device.

## DRPC-130-AL Embedded System

### 5.7 Save & Exit

Use the **Exit** menu (**BIOS Menu 27**) to load default BIOS values, optimal failsafe values and to save configuration changes.

```

Aptio Setup Utility - Copyright (C) 2018 American Megatrends, Inc.
Main   Advanced   Chipset   Security   Boot   Save & Exit
-----
Save Changes and Reset
Discard Changes and Reset

Restore Defaults
Save as User Defaults
Restore User Defaults

Reset the system after
saving the changes.

-----
<=>: Select Screen
↑ ↓: Select Item
Enter>Select
+ -   Change Opt.
F1    General Help
F2    Previous Values
F3    Optimized Defaults
F4    Save & Exit
ESC   Exit

Version 2.18.1263. Copyright (C) 2018 American Megatrends, Inc.

```

#### BIOS Menu 27: Save & Exit

##### → Save Changes and Reset

Use the **Save Changes and Reset** option to save the changes made to the BIOS options and reset the system.

##### → Discard Changes and Reset

Use the **Discard Changes and Reset** option to exit the system without saving the changes made to the BIOS configuration setup program.

##### → Restore Defaults

Use the **Restore Defaults** option to load the optimal default values for each of the parameters on the Setup menus. **F3 key can be used for this operation.**



→ **Save as User Defaults**

Use the **Save as User Defaults** option to save the changes done so far as user defaults.

→ **Restore User Defaults**

Use the **Restore User Defaults** option to restore the user defaults to all the setup options.

Chapter

6

# Interface Connectors

---

## 6.1 Peripheral Interface Connectors

The DRPC-130-AL embedded system motherboard comes with a number of peripheral interface connectors and configuration jumpers. The connector locations are shown in **Table 6-1** and **Figure 6-2**. The Pin 1 locations of the on-board connectors are also indicated in the diagrams. The connector pinouts for these connectors are listed in the following sections.

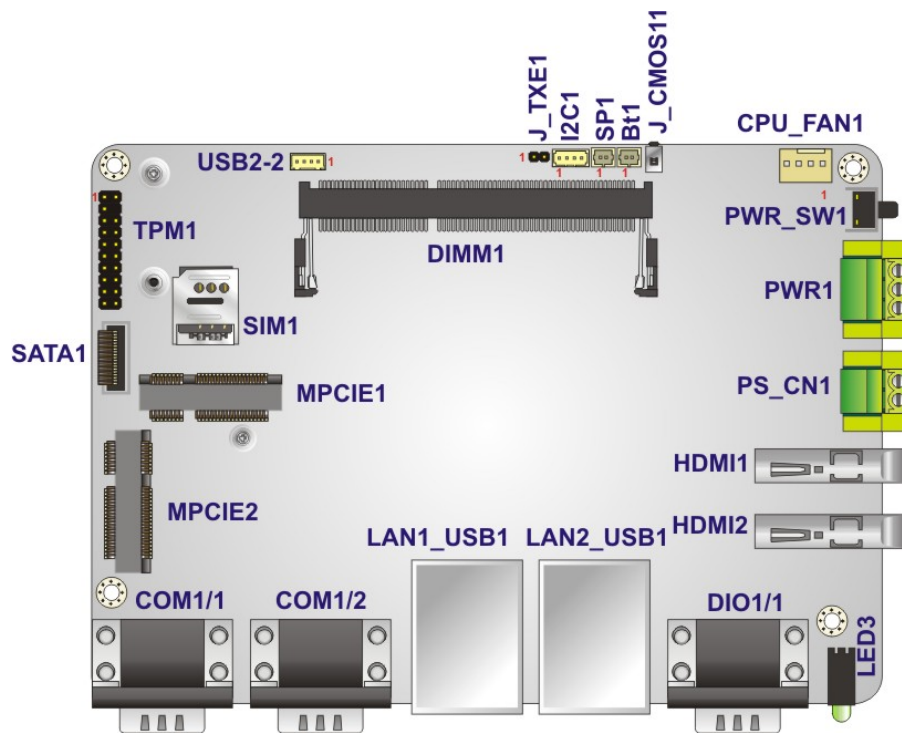

**Figure 6-1: Main Board Layout Diagram (Front Side)**

## DRPC-130-AL Embedded System

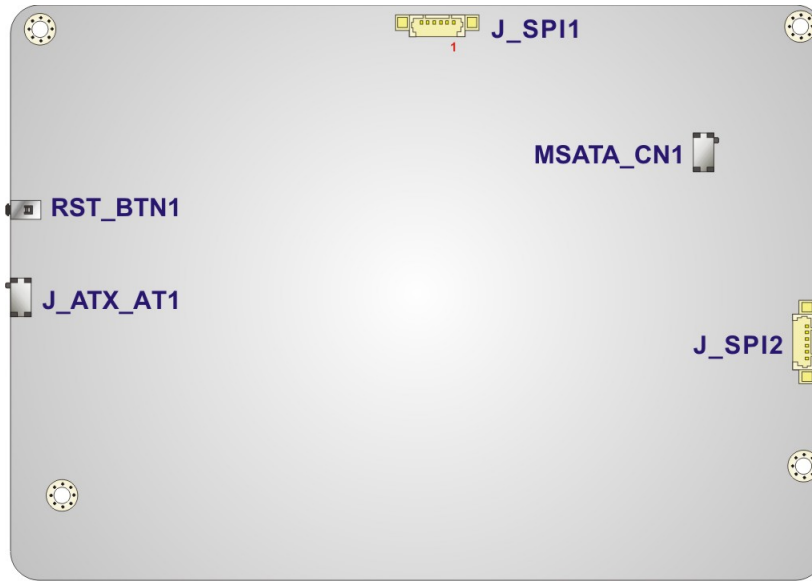

Figure 6-2: Main Board Layout Diagram (Solder Side)

## 6.2 Internal Peripheral Connectors

Internal peripheral connectors on the motherboard and are only accessible when the motherboard is outside of the chassis. The table below shows a list of the connectors on the motherboard. Pinouts of these connectors can be found in the following sections.

Connector	Type	Label
Battery connector	2-pin wafer	BT1
Buzzer connector	2-pin wafer	SP1
CPU fan connector	4-pin wafer	CPU_FAN1
I <sup>2</sup> C connector	4-pin wafer	I2C1
Memory slot	SO-DIMM connector	DIMM1
PCIe Mini slot (full-size/half-size)	Full-size/Half-size PCIe Mini slot	MPCIE1
PCIe Mini slot (half-size)	Half-size PCIe Mini slot	MPCIE2
SATA connector	SATA connector	SATA1
SPI flash connector	6-pin wafer	J_SPI1

Connector	Type	Label
SPI flash connector (EC)	6-pin wafer	J_SPI2
USB 2.0 connector	4-pin wafer	USB2-2
TPM connector	20-pin header	TPM1

**Table 6-1: Peripheral Interface Connectors**

### 6.2.1 Battery Connector (BT1)

PIN NO.	DESCRIPTION
1	+3V
2	GND

**Table 6-2: Battery Connector (BT1) Pinouts**

### 6.2.2 CPU Fan Connector (CPU\_FAN1)

PIN NO.	DESCRIPTION
1	GND
2	+5V
3	FANO1_EC
4	FANOUT_EC

**Table 6-3: CPU Fan Connector (CPU\_FAN1) Pinouts**

### 6.2.3 I<sup>2</sup>C Connector (I2C1)

PIN NO.	DESCRIPTION
1	GND
2	SMDAT
3	SMCLK
4	+V3.3

**Table 6-4: I<sup>2</sup>C Connector (I2C1) Pinouts**



**6.2.4 SATA Connector (SATA1)**

PIN NO.	DESCRIPTION	PIN NO.	DESCRIPTION
1	GND	11	+V5S
2	GND	12	N/A
3	GND	13	N/A
4	GND	14	GND
5	GND	15	SATA_RXP0
6	N/A	16	SATA_RXN0
7	+V5S	17	GND
8	+V5S	18	SATA_TXN0
9	+V5S	19	SATA_TXP0
10	+V5S	20	GND

**Table 6-5: SATA 3Gb/s Connector (SATA1) Pinouts**

**6.2.5 USB 2.0 Connector (USB2-2)**

PIN NO.	DESCRIPTION
1	+5VSUS
2	-DATA4
3	+DATA4
4	GND

**Table 6-6: USB 2.0 Connector (USB2-2) Pinouts**

**6.2.6 SPI Flash Connector (J\_SPI1)**

PIN NO.	DESCRIPTION
1	+1.8V
2	SPI_CS
3	SPI_SO
4	SPI_CLK
5	SPI_SI
6	GND

**Table 6-7: SPI Flash Connector (J\_SPI1) Pinouts**

### 6.2.7 SPI Flash Connector - EC (J\_SPI2)

PIN NO.	DESCRIPTION
1	+V3.3
2	SPI_CS#0_CN_EC
3	SPI_SO_SW_EC
4	SPI_CLK_SW_EC
5	SPI_SI_SW_EC
6	GND

**Table 6-8: SPI Flash Connector - EC (J\_SPI2) Pinouts**

### 6.2.8 TPM Connector (TPM1)

PIN NO.	DESCRIPTION	PIN NO.	DESCRIPTION
1	LPC_TPM	2	GND
3	LPC_FRAME_N	4	N/A
5	BUF_PLTRST#	6	+V5
7	LPC_AD3	8	LPC_AD2
9	+V3.3	10	LPC_AD1
11	LPC_AD0	12	GND
13	SMB_CLK	14	SMB_DATA
15	+V3.3A	16	LPC_SERIRQ
17	GND	18	LPC_CLKRUN_N
19	SUS_STAT_N	20	+V3.3

**Table 6-9: TPM Connector (TPM1) Pinouts**

Appendix

**A**

# Regulatory Compliance

---

**DECLARATION OF CONFORMITY**

This equipment is in conformity with the following EU directives:

- EMC Directive 2004/30/EU
- Low-Voltage Directive 2014/35/EU
- RoHS II Directive 2015/863/EU

If the user modifies and/or install other devices in the equipment, the CE conformity declaration may no longer apply.

If this equipment has telecommunications functionality, it also complies with the requirements of the R&TTE Directive 1999/5/EC.

---

English

IEI Integration Corp declares that this equipment is in compliance with the essential requirements and other relevant provisions of Directive 1999/5/EC.

---

Български [Bulgarian]

IEI Integration Corp. декларира, че този оборудване е в съответствие със съществените изисквания и другите приложими правила на Директива 1999/5/EC.

---

Česky [Czech]

IEI Integration Corp tímto prohlašuje, že tento zařizení je ve shodě se základními požadavky a dalšími příslušnými ustanoveními směrnice 1999/5/ES.

---

Dansk [Danish]

IEI Integration Corp erklærer herved, at følgende udstyr overholder de væsentlige krav og øvrige relevante krav i direktiv 1999/5/EF.

---

Deutsch [German]

IEI Integration Corp, erklärt dieses Gerät entspricht den grundlegenden Anforderungen und den weiteren entsprechenden Vorgaben der Richtlinie 1999/5/EU.

---

Eesti [Estonian]

IEI Integration Corp deklareerib seadme seadme vastavust direktiivi 1999/5/EÜ põhinõuetele ja nimetatud direktiivist tulenevatele teistele asjakohastele sätetele.

---

## DRPC-130-AL Embedded System

---

### Español [Spanish]

IEI Integration Corp declara que el equipo cumple con los requisitos esenciales y cualesquiera otras disposiciones aplicables o exigibles de la Directiva 1999/5/CE.

---

### Ελληνική [Greek]

IEI Integration Corp ΔΗΛΩΝΕΙ ΟΤΙ ΕΞΟΠΛΙΣΜΟΣ ΣΥΜΜΟΡΦΩΝΕΤΑΙ ΠΡΟΣ ΤΙΣ ΟΥΣΙΩΔΕΙΣ ΑΠΑΙΤΗΣΕΙΣ ΚΑΙ ΤΙΣ ΛΟΙΠΕΣ ΣΧΕΤΙΚΕΣ ΔΙΑΤΑΞΕΙΣ ΤΗΣ ΟΔΗΓΙΑΣ 1999/5/EK.

---

### Français [French]

IEI Integration Corp déclare que l'appareil est conforme aux exigences essentielles et aux autres dispositions pertinentes de la directive 1999/5/CE.

---

### Italiano [Italian]

IEI Integration Corp dichiara che questo apparecchio è conforme ai requisiti essenziali ed alle altre disposizioni pertinenti stabilite dalla direttiva 1999/5/CE.

---

### Latviski [Latvian]

IEI Integration Corp deklarē, ka iekārta atbilst būtiskajām prasībām un citiem ar to saistītajiem noteikumiem Direktīvas 1999/5/EK.

---

### Lietuvių [Lithuanian]

IEI Integration Corp deklaruoja, kad šis įranga atitinka esminius reikalavimus ir kitas 1999/5/EB Direktyvos nuostatas.

---

### Nederlands [Dutch]

IEI Integration Corp dat het toestel toestel in overeenstemming is met de essentiële eisen en de andere relevante bepalingen van richtlijn 1999/5/EG.

---

### Malti [Maltese]

IEI Integration Corp jiddikjara li dan prodott jikkonforma mal-ħtiġijiet essenzjali u ma provvedimenti oħrajn relevanti li hemm fid-Direttiva 1999/5/EC.

---

### Magyar [Hungarian]

IEI Integration Corp nyilatkozom, hogy a berendezés megfelel a vonatkozó alapvető követelményeknek és az 1999/5/EC irányelv egyéb előírásainak.

---

### Polski [Polish]

IEI Integration Corp oświadcza, że wyrobu jest zgodny z zasadniczymi wymogami oraz pozostałymi stosownymi postanowieniami Dyrektywy 1999/5/EC.

---

### Português [Portuguese]

IEI Integration Corp declara que este equipamento está conforme com os requisitos essenciais e outras disposições da Directiva 1999/5/CE.

---



---

### Româna [Romanian]

IEI Integration Corp declară că acest echipament este în conformitate cu cerințele esențiale și cu celelalte prevederi relevante ale Directivei 1999/5/CE.

---

### Slovensko [Slovenian]

IEI Integration Corp izjavlja, da je ta opreme v skladu z bistvenimi zahtevami in ostalimi relevantnimi določili direktive 1999/5/ES.

---

### Slovensky [Slovak]

IEI Integration Corp týmto vyhlasuje, že zariadenia spĺňa základné požiadavky a všetky príslušné ustanovenia Smernice 1999/5/ES.

---

### Suomi [Finnish]

IEI Integration Corp vakuuttaa täten että laitteet on direktiivin 1999/5/EY oleellisten vaatimusten ja sitä koskevien direktiivin muiden ehtojen mukainen.

---

### Svenska [Swedish]

IEI Integration Corp förklarar att denna utrustningstyp står i överensstämmelse med de väsentliga egenskapskrav och övriga relevanta bestämmelser som framgår av direktiv 1999/5/EG.

---

## DRPC-130-AL Embedded System

### FCC WARNING



This equipment complies with Part 15 of the FCC Rules. Operation is subject to the following two conditions:

- This device may not cause harmful interference, and
- This device must accept any interference received, including interference that may cause undesired operation.

This equipment has been tested and found to comply with the limits for a Class A digital device, pursuant to part 15 of the FCC Rules. These limits are designed to provide reasonable protection against harmful interference when the equipment is operated in a commercial environment. This equipment generates, uses, and can radiate radio frequency energy and, if not installed and used in accordance with the instruction manual, may cause harmful interference to radio communications. Operation of this equipment in a residential area is likely to cause harmful interference in which case the user will be required to correct the interference at his own expense.

### ROHS STATEMENT



The label on the product indicates this product conforms to European (EU) Restriction of Hazardous Substances (RoHS) that set maximum concentration limits on hazardous materials used in electrical and electronic equipment.

### CHINA ROHS



The label on the product indicates the estimated “Environmentally Friendly Use Period” (EFUP). This is an estimate of the number of years that these substances would “not leak out or undergo abrupt change.” This product may contain replaceable sub-assemblies/components which have a shorter EFUP such as batteries and lamps. These components will be separately marked.

Appendix

**B**

# Safety Precautions

---

## DRPC-130-AL Embedded System

### B.1 Safety Precautions

---



#### WARNING:

The precautions outlined in this appendix should be strictly followed. Failure to follow these precautions may result in permanent damage to the DRPC-130-AL.

---

Please follow the safety precautions outlined in the sections that follow:

#### B.1.1 General Safety Precautions

Please ensure the following safety precautions are adhered to at all times.

- ***Make sure the power is turned off and the power cord is disconnected*** when moving, installing or modifying the system.
- ***Do not apply voltage levels that exceed the specified voltage range.*** Doing so may cause fire and/or an electrical shock.
- ***Electric shocks can occur*** if opened while still powered on.
- ***Do not drop or insert any objects*** into the ventilation openings.
- ***If considerable amounts of dust, water, or fluids enter the system***, turn off the power supply immediately, unplug the power cord, and contact the system vendor.
- **DO NOT:**
  - Drop the system against a hard surface.
  - Strike or exert excessive force onto the LCD panel.
  - Touch any of the LCD panels with a sharp object
  - In a site where the ambient temperature exceeds the rated temperature

### B.1.2 Anti-static Precautions

---



#### WARNING:

Failure to take ESD precautions during the installation of the DRPC-130-AL may result in permanent damage to the DRPC-130-AL and severe injury to the user.

---

Electrostatic discharge (ESD) can cause serious damage to electronic components, including the DRPC-130-AL. Dry climates are especially susceptible to ESD. It is therefore critical that whenever the DRPC-130-AL is opened and any of the electrical components are handled, the following anti-static precautions are strictly adhered to.

- ***Wear an anti-static wristband:*** Wearing a simple anti-static wristband can help to prevent ESD from damaging any electrical component.
- ***Self-grounding:*** Before handling any electrical component, touch any grounded conducting material. During the time the electrical component is handled, frequently touch any conducting materials that are connected to the ground.
- ***Use an anti-static pad:*** When configuring or working with an electrical component, place it on an anti-static pad. This reduces the possibility of ESD damage.
- ***Only handle the edges of the electrical component:*** When handling the electrical component, hold the electrical component by its edges.

### B.1.3 Explanation of Graphical Symbols



This symbol warns the user that the part has this symbol is hot. Therefore, it is dangerous to make any kind of contact with this part.



This symbol alerts the user that important information concerning the operation and maintenance of this unit has been included. Therefore, the information should be read carefully in order to avoid any problems.



## DRPC-130-AL Embedded System

### B.1.4 Product Disposal

---



#### CAUTION:

Risk of explosion if the battery is replaced by an incorrect type;

Replacement of a battery with an incorrect type that can defeat a safeguard (for example, in the case of some lithium battery types);

Disposal of a battery into fire or a hot oven, or mechanically crushing or cutting of a battery, that can result in an explosion;

Leaving a battery in an extremely high temperature surrounding environment that can result in an explosion or the leakage of flammable liquid or gas;

A battery subjected to extremely low air pressure that may result in an explosion or the leakage of flammable liquid or gas.

Dispose of used batteries according to instructions and local regulations.

---

- Outside the European Union - If you wish to dispose of used electrical and electronic products outside the European Union, please contact your local authority so as to comply with the correct disposal method.
- Within the European Union:

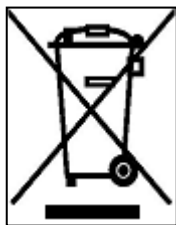

EU-wide legislation, as implemented in each Member State, requires that waste electrical and electronic products carrying the mark (left) must be disposed of separately from normal household waste. This includes monitors and electrical accessories, such as signal cables or power cords. When you need to dispose of your display products, please follow the guidance of your local authority, or ask the shop where you purchased the product. The mark on electrical and electronic products only applies to the current European Union Member States.

Please follow the national guidelines for electrical and electronic product disposal.

## B.2 Maintenance and Cleaning Precautions

When maintaining or cleaning the DRPC-130-AL, please follow the guidelines below.

### B.2.1 Maintenance and Cleaning

Prior to cleaning any part or component of the DRPC-130-AL, please read the details below.

- The interior of the DRPC-130-AL does not require cleaning. Keep fluids away from the DRPC-130-AL interior.
- Be cautious of all small removable components when vacuuming the DRPC-130-AL.
- Turn the DRPC-130-AL off before cleaning the DRPC-130-AL.
- Never drop any objects or liquids through the openings of the DRPC-130-AL.
- Be cautious of any possible allergic reactions to solvents or chemicals used when cleaning the DRPC-130-AL.
- Avoid eating, drinking and smoking within vicinity of the DRPC-130-AL.

### B.2.2 Cleaning Tools

Some components in the DRPC-130-AL may only be cleaned using a product specifically designed for the purpose. In such case, the product will be explicitly mentioned in the cleaning tips. Below is a list of items to use when cleaning the DRPC-130-AL.

- **Cloth** – Although paper towels or tissues can be used, a soft, clean piece of cloth is recommended when cleaning the DRPC-130-AL.
- **Water or rubbing alcohol** – A cloth moistened with water or rubbing alcohol can be used to clean the DRPC-130-AL.
- **Using solvents** – The use of solvents is not recommended when cleaning the DRPC-130-AL as they may damage the plastic parts.
- **Vacuum cleaner** – Using a vacuum specifically designed for computers is one of the best methods of cleaning the DRPC-130-AL. Dust and dirt can restrict the airflow in the DRPC-130-AL and cause its circuitry to corrode.
- **Swabs** - Swabs moistened with rubbing alcohol or water are excellent tools for wiping hard to reach areas. Whenever possible, it is best to use lint free swabs such as foam swabs for cleaning.

Appendix

C

# Digital I/O Interface

---

The DIO connector on the DRPC-130-AL is interfaced to GPIO ports on the Super I/O chipset. The DIO has both 8-bit digital inputs and 8-bit digital outputs. The digital inputs and digital outputs are generally control signals that control the on/off circuit of external devices or TTL devices. Data can be read or written to the selected address to enable the DIO functions.



### NOTE:

For further information, please refer to the datasheet for the Super I/O chipset.

The BIOS interrupt call **INT 15H** controls the digital I/O.

### INT 15H:

<b>AH – 6FH</b>	
<u>Sub-function:</u>	
<b>AL – 8</b>	:Set the digital port as INPUT
<b>AL</b>	:Digital I/O input value

### Assembly Language Sample 1

```
MOV    AX, 6F08H    ;setting the digital port as input
INT    15H        ;
```

**AL low byte = value**

## DRPC-130-AL Embedded System

<b>AH – 6FH</b>	
<u>Sub-function:</u>	
<b>AL – 9</b>	:Set the digital port as OUTPUT
<b>BL</b>	:Digital I/O output value

**Assembly Language Sample 2**

```
MOV    AX, 6F09H      ;setting the digital port as output  
MOV    BL, 09H        ;digital value is 09H  
INT    15H           ;
```

**Digital Output is 1001b**



Appendix

**D**

# Watchdog Timer

---

## DRPC-130-AL Embedded System



### NOTE:

The following discussion applies to DOS. Contact IEI support or visit the IEI website for drivers for other operating systems.

The Watchdog Timer is a hardware-based timer that attempts to restart the system when it stops working. The system may stop working because of external EMI or software bugs. The Watchdog Timer ensures that standalone systems like ATMs will automatically attempt to restart in the case of system problems.

A BIOS function call (INT 15H) is used to control the Watchdog Timer.

INT 15H:

<b>AH – 6FH Sub-function:</b>	
AL – 2:	Sets the Watchdog Timer's period.
BL:	Time-out value (Its unit-second is dependent on the item "Watchdog Timer unit select" in CMOS setup).

**Table D-1: AH-6FH Sub-function**

Call sub-function 2 to set the time-out period of Watchdog Timer first. If the time-out value is not zero, the Watchdog Timer starts counting down. When the timer value reaches zero, the system resets. To ensure that this reset condition does not occur, calling sub-function 2 must periodically refresh the Watchdog Timer. However, the watchdog timer is disabled if the time-out value is set to zero.

A tolerance of at least 10% must be maintained to avoid unknown routines within the operating system (DOS), such as disk I/O that can be very time-consuming.

**NOTE:**

The Watchdog Timer is activated through software. The software application that activates the Watchdog Timer must also deactivate it when closed. If the Watchdog Timer is not deactivated, the system will automatically restart after the Timer has finished its countdown.

**EXAMPLE PROGRAM:**

**; INITIAL TIMER PERIOD COUNTER**

;

**W\_LOOP:**

;

```

MOV      AX, 6F02H      ;setting the time-out value
MOV      BL, 30         ;time-out value is 48 seconds
INT      15H

```

;

**; ADD THE APPLICATION PROGRAM HERE**

;

```

CMP      EXIT_AP, 1     ;is the application over?
JNE      W_LOOP        ;No, restart the application

MOV      AX, 6F02H     ;disable Watchdog Timer
MOV      BL, 0         ;
INT      15H

```

;

**; EXIT ;**

Appendix

**E**

# Error Beep Code

---

### E.1 PEI Beep Codes

Number of Beeps	Description
1	Memory not Installed
1	Memory was installed twice (InstallPeiMemory routine in PEI Core called twice)
2	Recovery started
3	DXE IPL was not found
3	DXE Core Firmware Volume was not found
4	Recovery failed
4	S3 Resume failed
7	Reset PPI is not available

### E.2 DXE Beep Codes

Number of Beeps	Description
1	Invalid password
4	Some of the Architectural Protocols are not available
5	No Console Output Devices are found
5	No Console Input Devices are found
6	Flash update is failed
7	Reset protocol is not available
8	Platform PCI resource requirements cannot be met



**NOTE:**

If you have any question, please contact IEI for further assistance.



Appendix

**F**

# Hazardous Materials Disclosure

---

The details provided in this appendix are to ensure that the product is compliant with the Peoples Republic of China (China) RoHS standards. The table below acknowledges the presences of small quantities of certain materials in the product, and is applicable to China RoHS only.

A label will be placed on each product to indicate the estimated “Environmentally Friendly Use Period” (EFUP). This is an estimate of the number of years that these substances would “not leak out or undergo abrupt change.” This product may contain replaceable sub-assemblies/components which have a shorter EFUP such as batteries and lamps. These components will be separately marked.

Please refer to the following table.

Part Name	Toxic or Hazardous Substances and Elements					
	Lead (Pb)	Mercury (Hg)	Cadmium (Cd)	Hexavalent Chromium (CR(VI))	Polybrominated Biphenyls (PBB)	Polybrominated Diphenyl Ethers (PBDE)
Housing	O	O	O	O	O	O
Display	O	O	O	O	O	O
Printed Circuit Board	O	O	O	O	O	O
Metal Fasteners	O	O	O	O	O	O
Cable Assembly	O	O	O	O	O	O
Fan Assembly	O	O	O	O	O	O
Power Supply Assemblies	O	O	O	O	O	O
Battery	O	O	O	O	O	O

O: This toxic or hazardous substance is contained in all of the homogeneous materials for the part is below the limit requirement in SJ/T11363-2006 (now replaced by GB/T 26572-2011).

X: This toxic or hazardous substance is contained in at least one of the homogeneous materials for this part is above the limit requirement in SJ/T11363-2006 (now replaced by GB/T 26572-2011).

## DRPC-130-AL Embedded System

此附件旨在确保本产品符合中国 RoHS 标准。以下表格标示此产品中某有毒物质的含量符合中国 RoHS 标准规定的限量要求。

本产品上会附有“环境友好使用期限”的标签，此期限是估算这些物质“不会有泄漏或突变”的年限。本产品可能包含有较短的环境友好使用期限的可替换元件，像是电池或灯管，这些元件将会单独标示出来。

部件名称	有毒有害物质或元素					
	铅 (Pb)	汞 (Hg)	镉 (Cd)	六价铬 (CR(VI))	多溴联苯 (PBB)	多溴二苯 醚 (PBDE)
壳体	○	○	○	○	○	○
显示	○	○	○	○	○	○
印刷电路板	○	○	○	○	○	○
金属螺帽	○	○	○	○	○	○
电缆组装	○	○	○	○	○	○
风扇组装	○	○	○	○	○	○
电力供应组装	○	○	○	○	○	○
电池	○	○	○	○	○	○

○: 表示该有毒有害物质在该部件所有物质材料中的含量均在 SJ/T 11363-2006 (现由 GB/T 26572-2011 取代) 标准规定的限量要求以下。

X: 表示该有毒有害物质至少在该部件的某一均质材料中的含量超出 SJ/T 11363-2006 (现由 GB/T 26572-2011 取代) 标准规定的限量要求。